

# Flip Books: Rhyming Words Match

You need: construction paper, loose leaf rings, hole punch

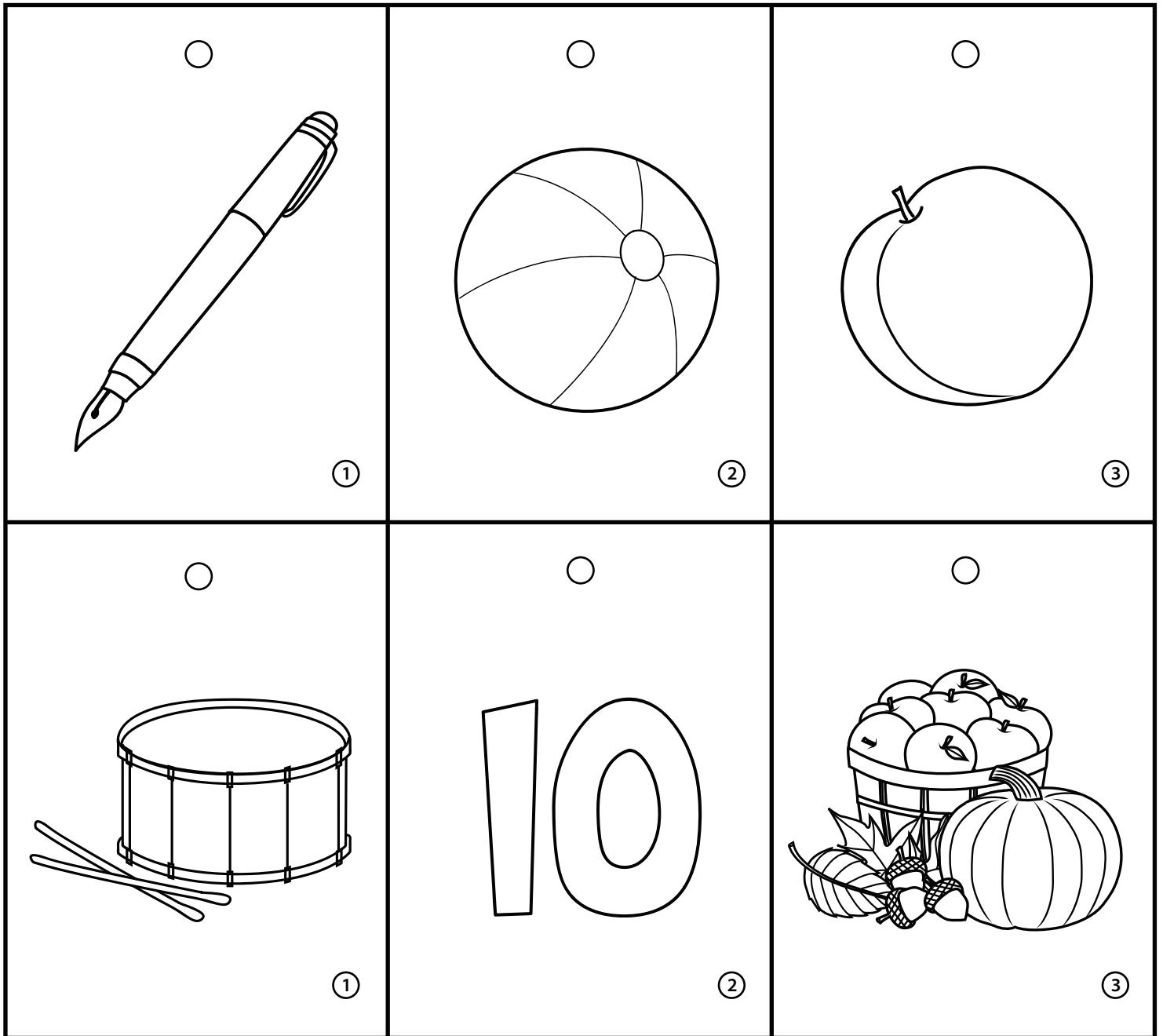

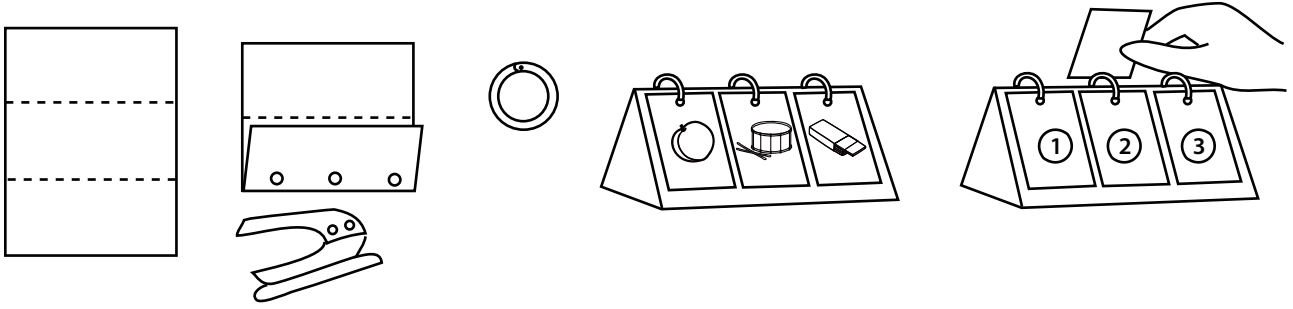

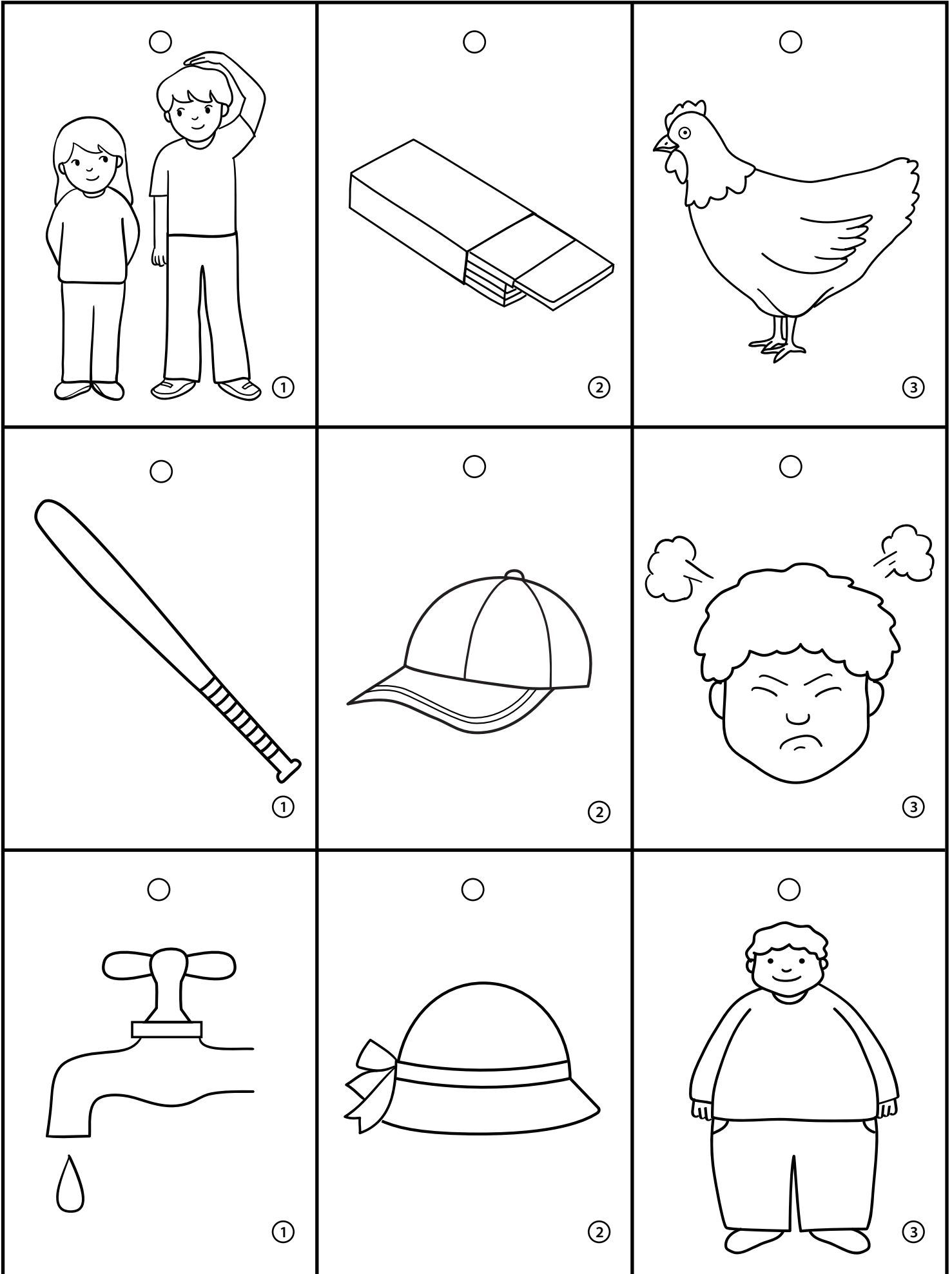
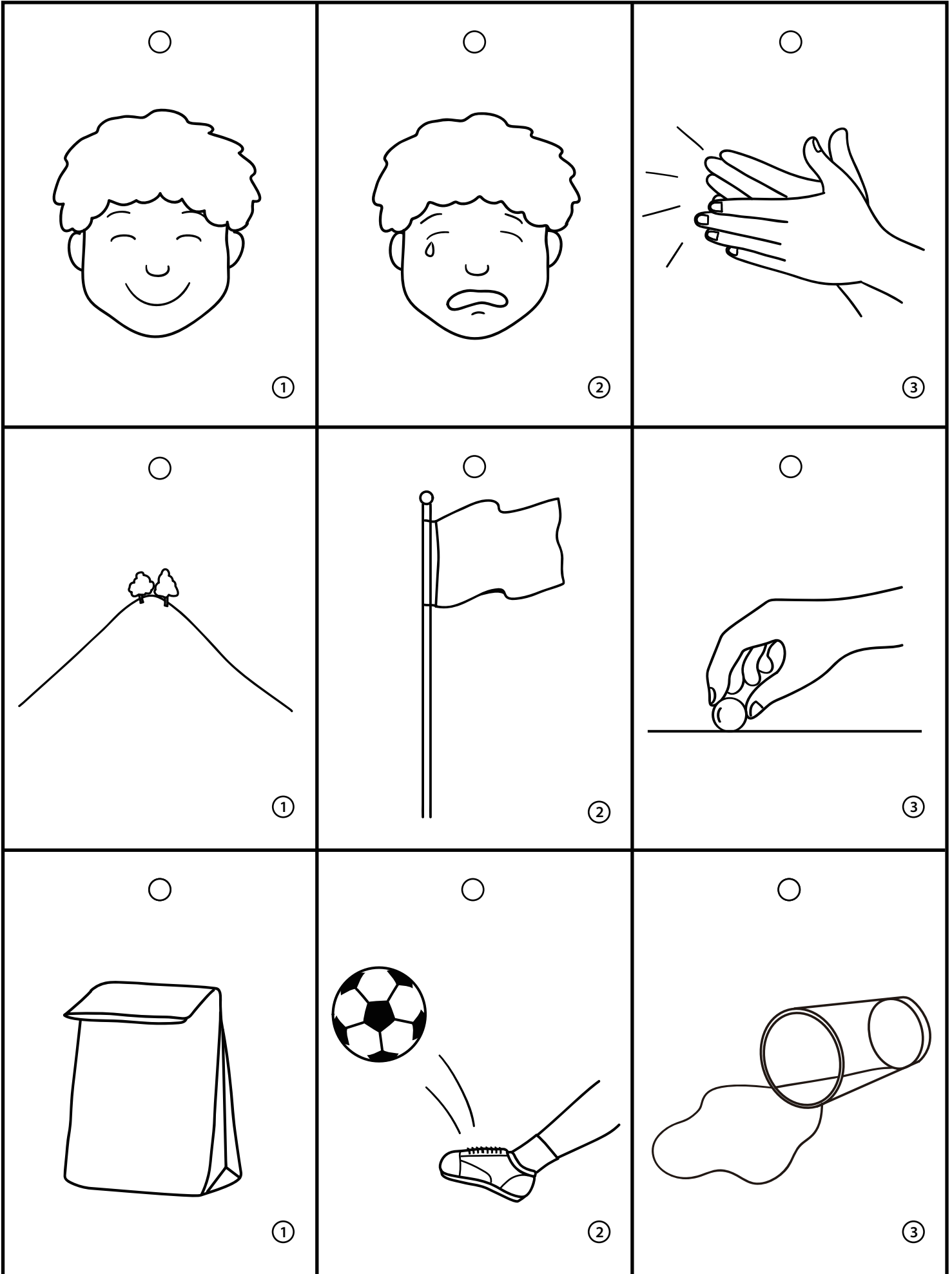

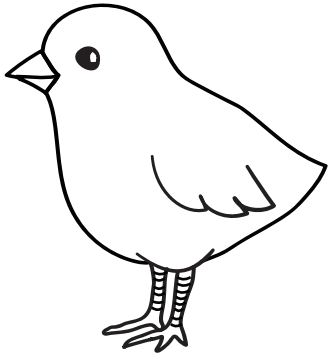

①

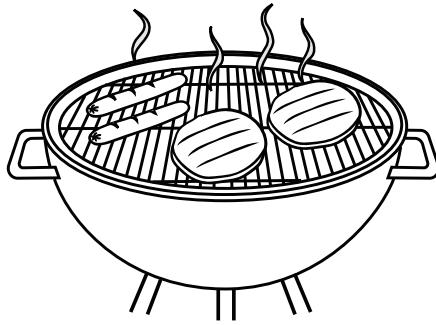

②

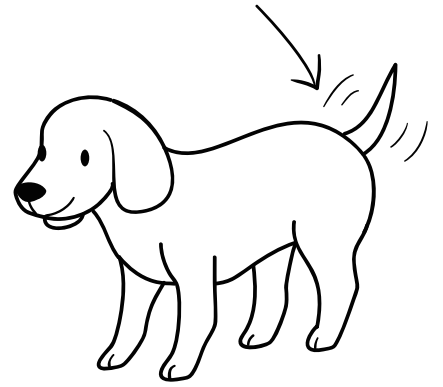

③

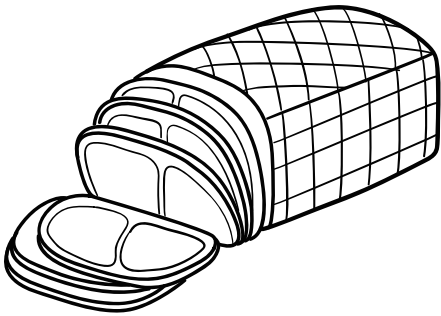

①

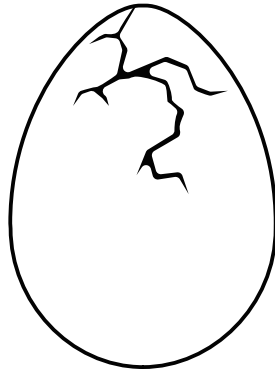

②



③

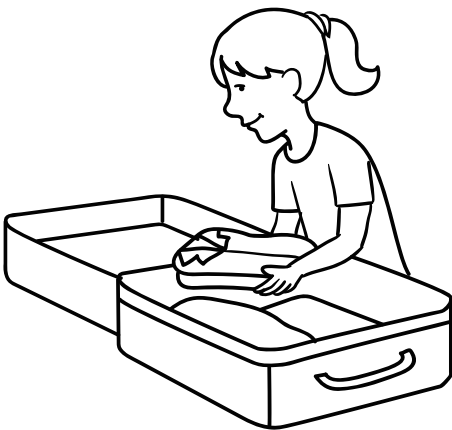

①

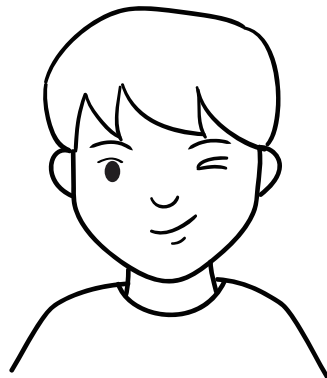

②

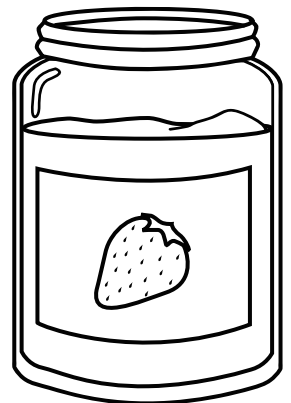

③

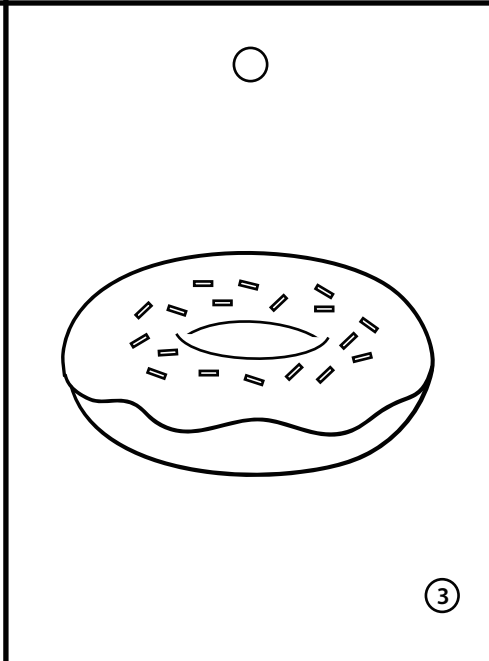
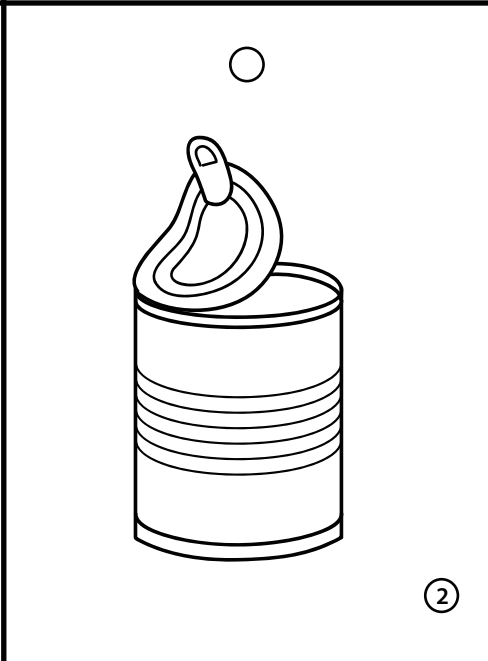
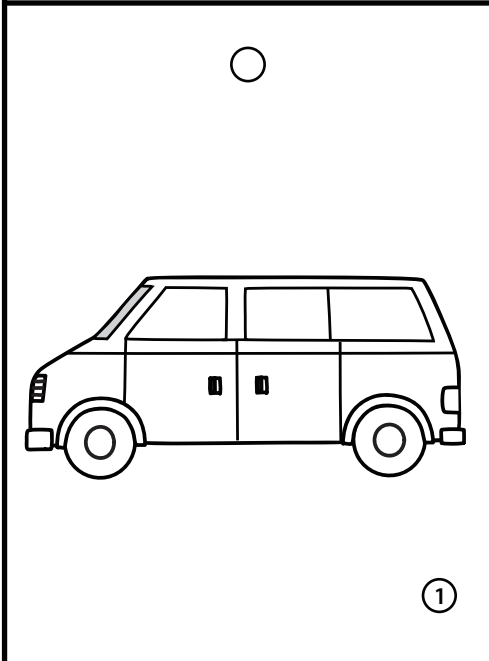
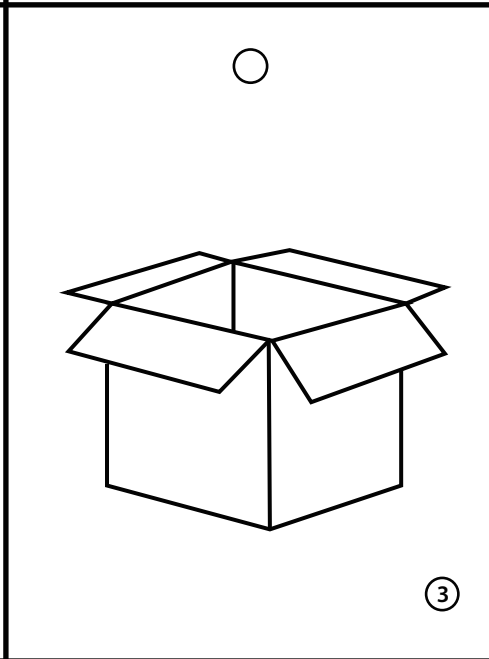
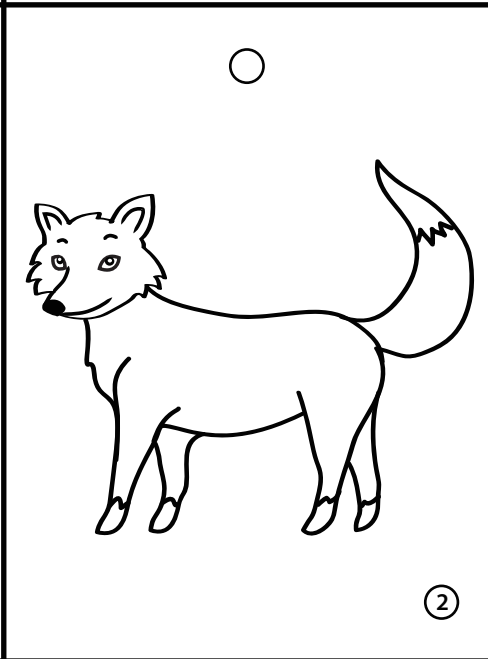
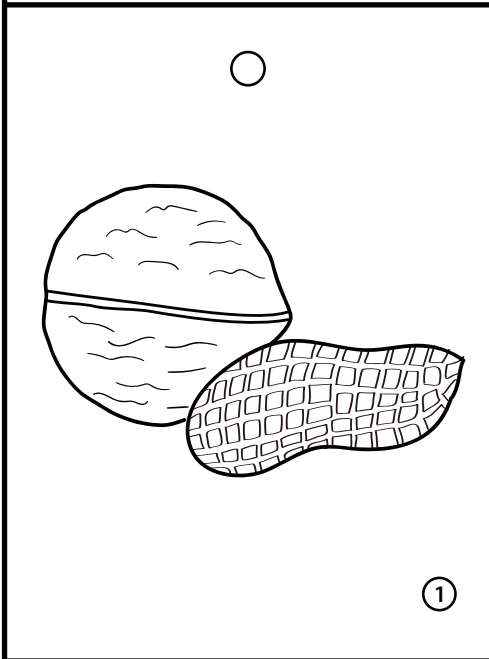
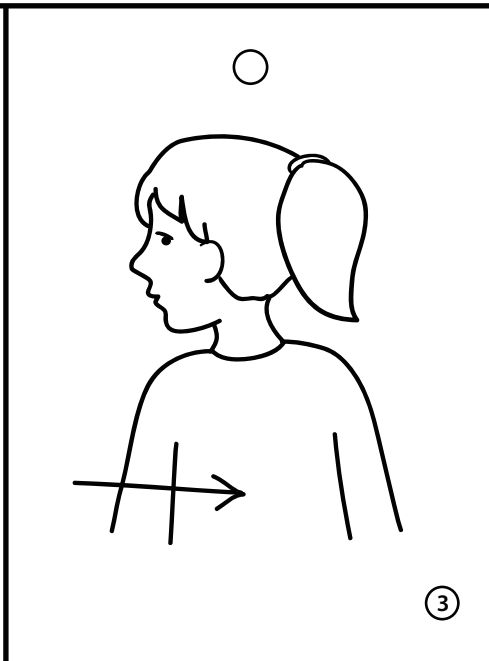
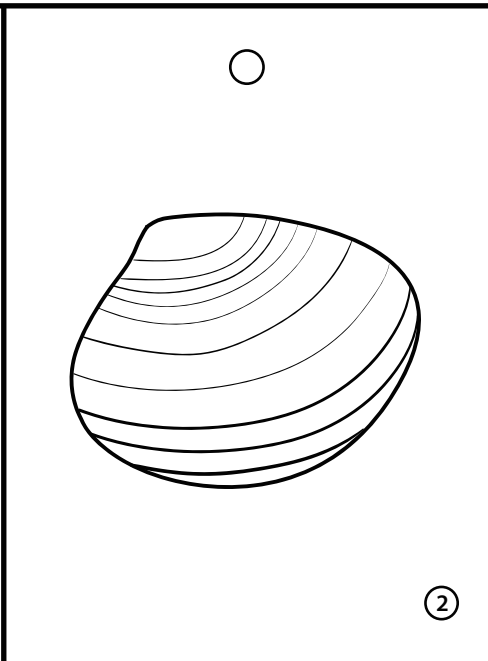

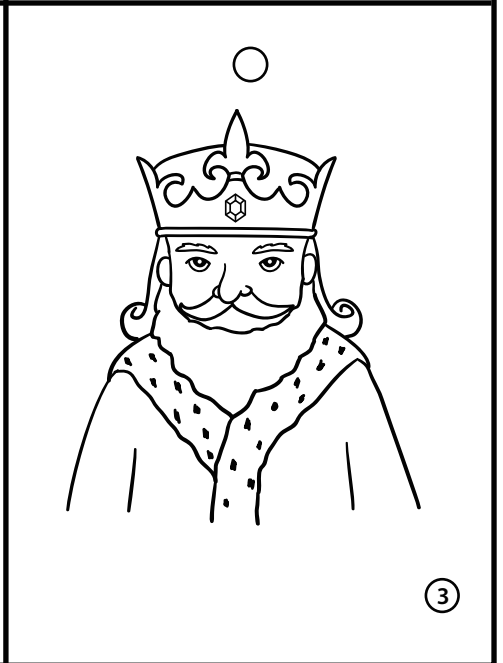
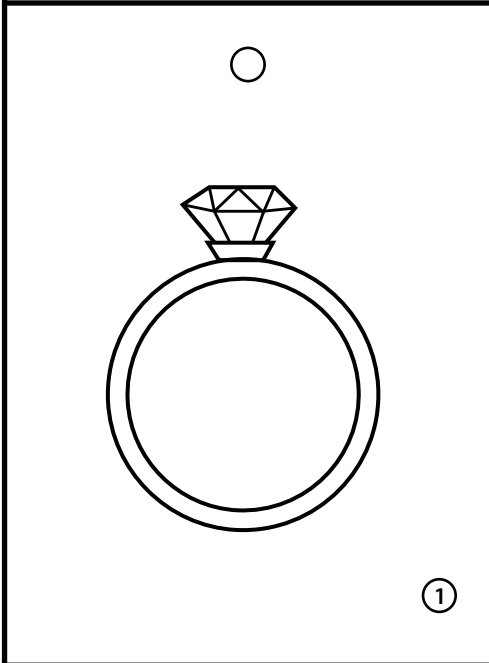
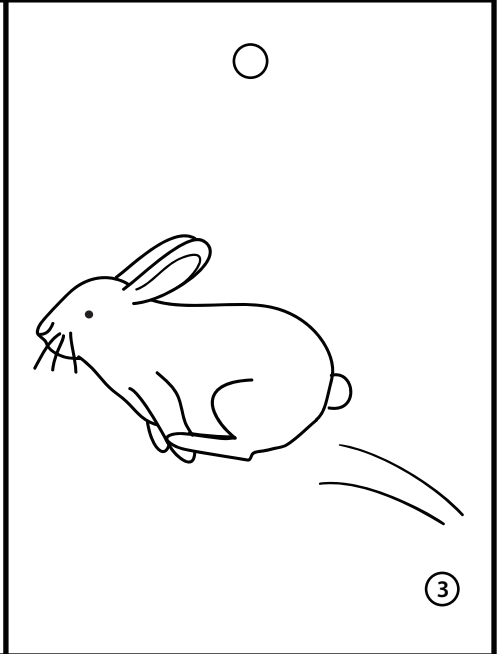
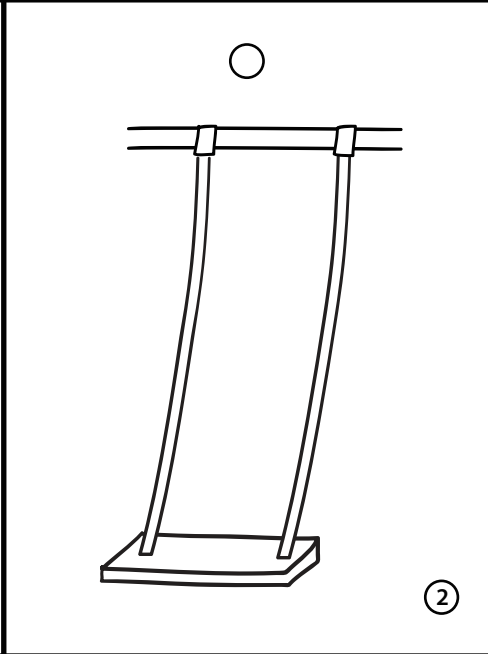
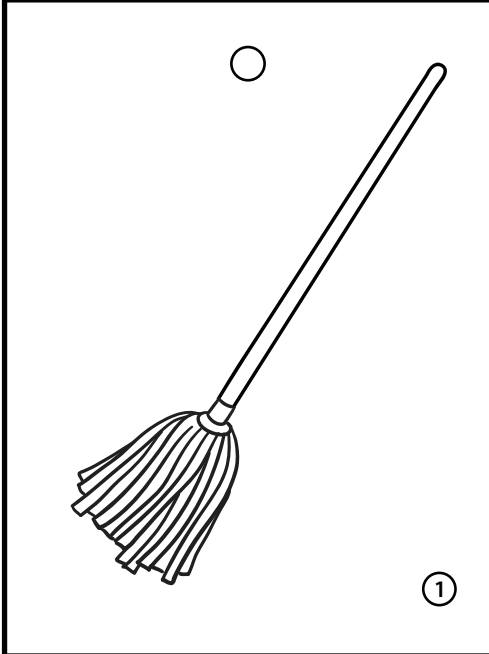
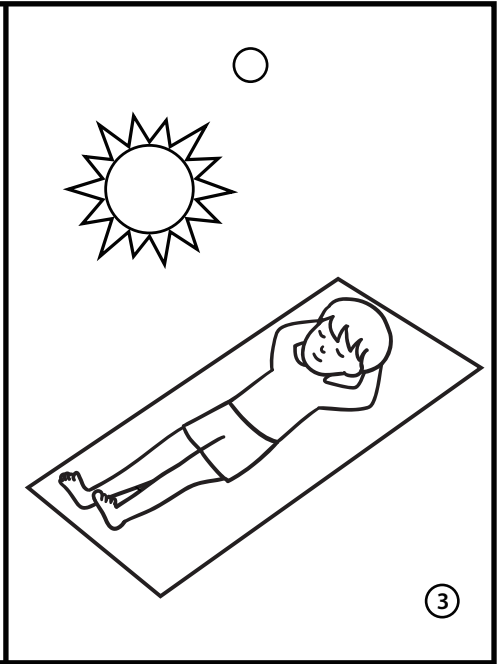
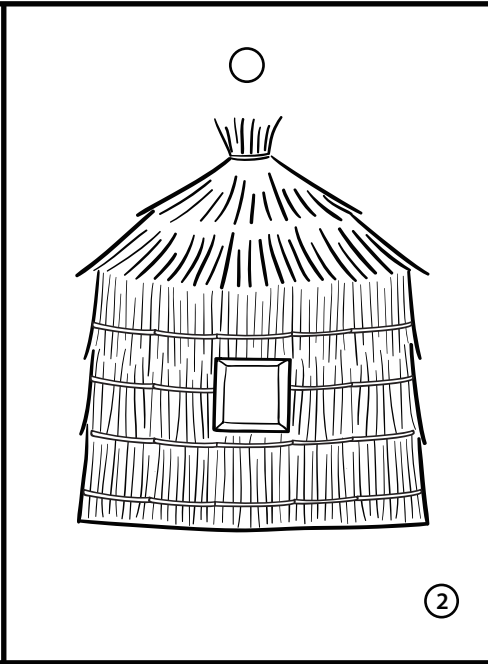
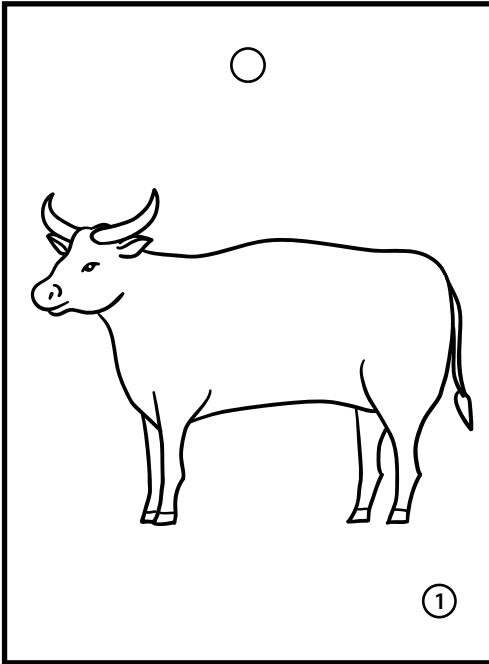

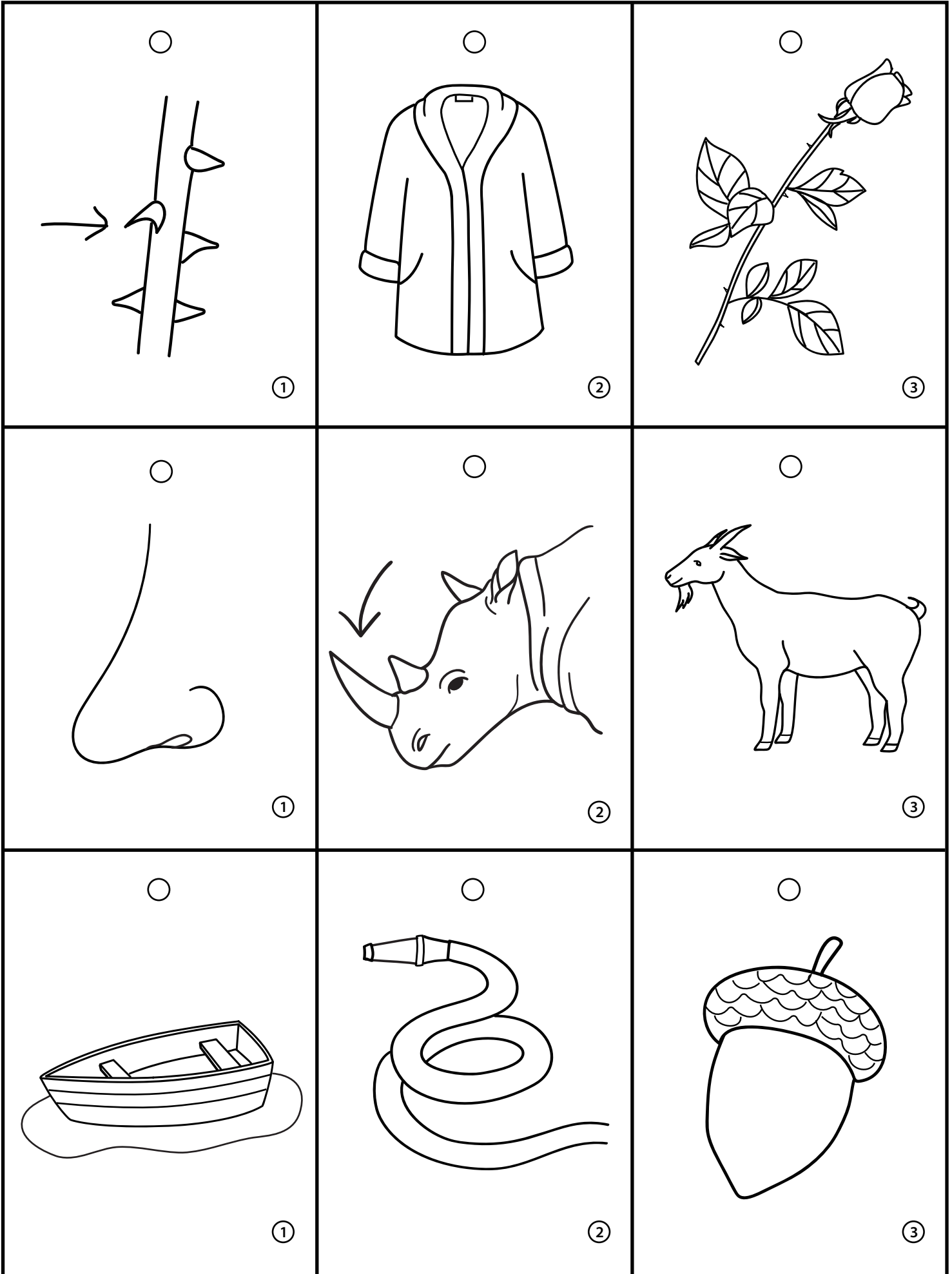

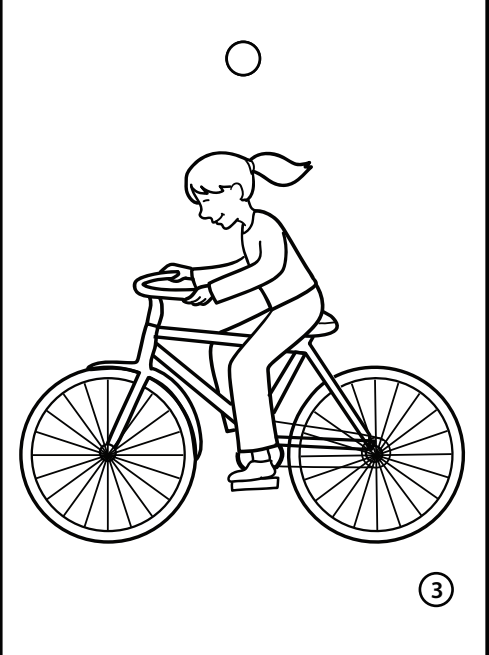
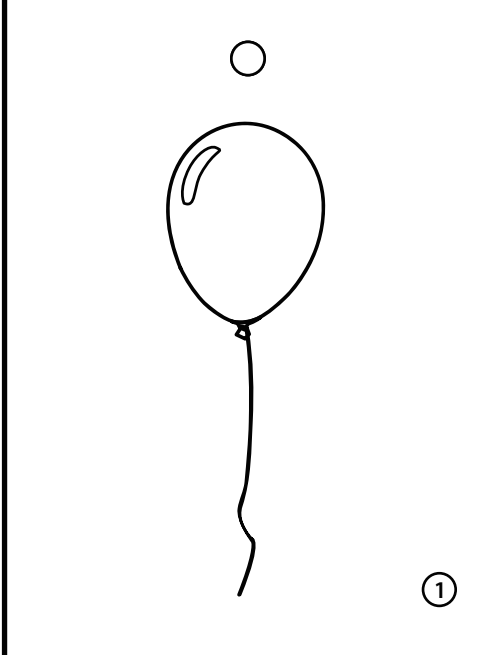
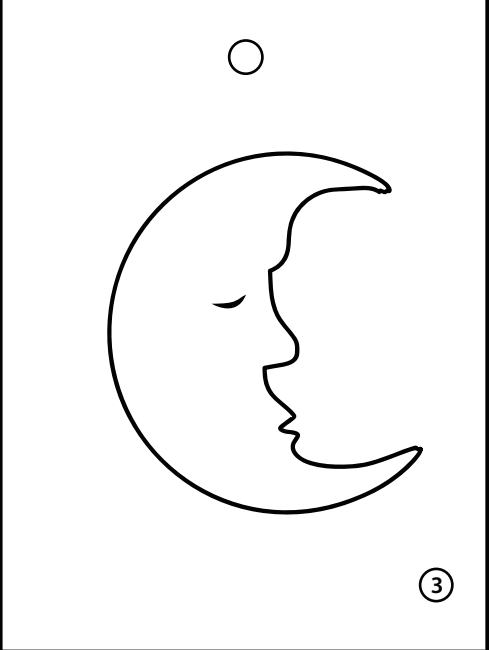
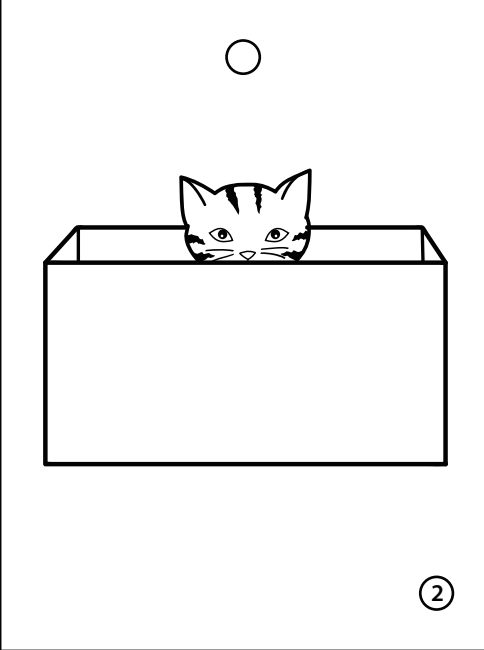
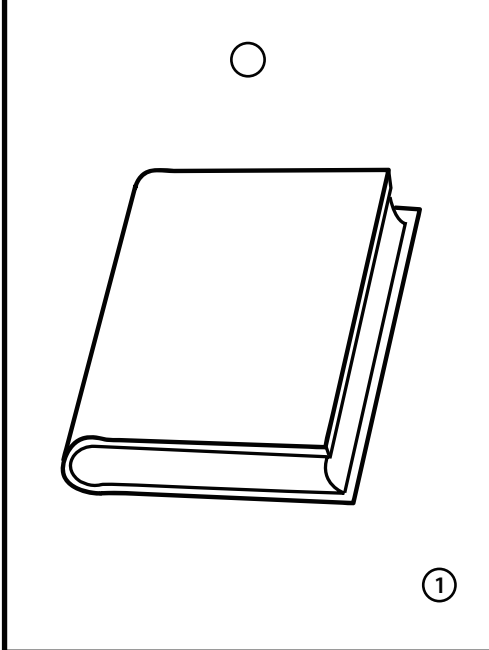
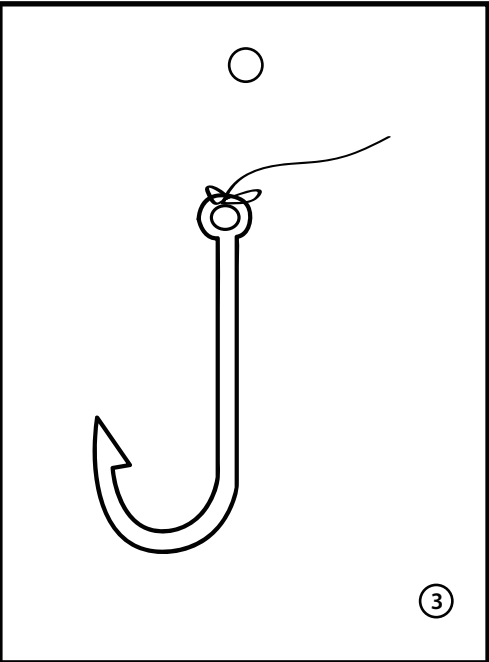
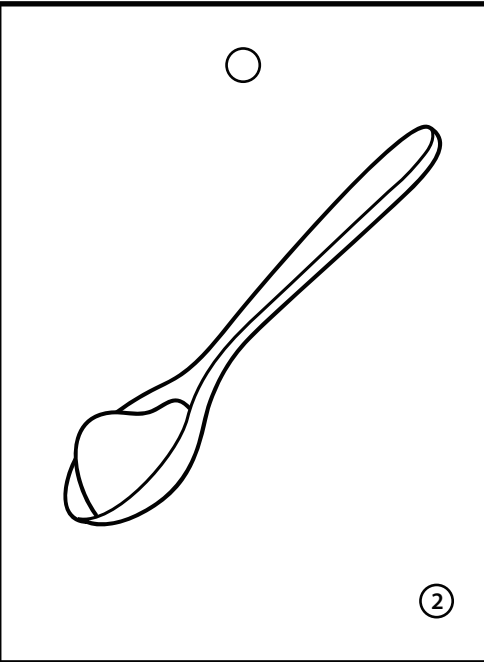
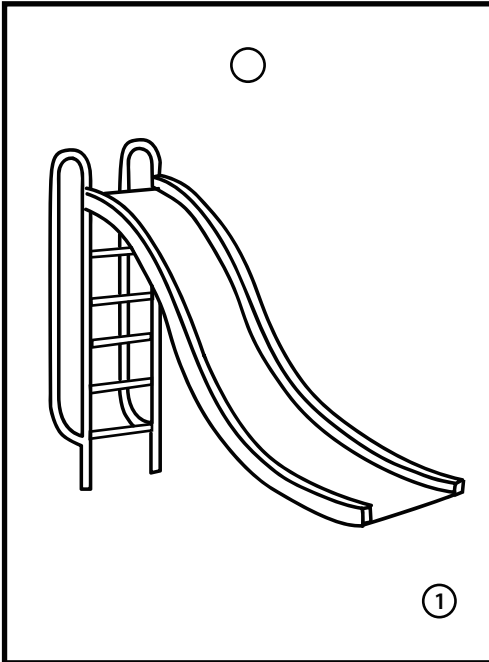



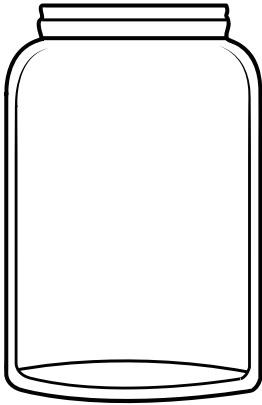

①



②

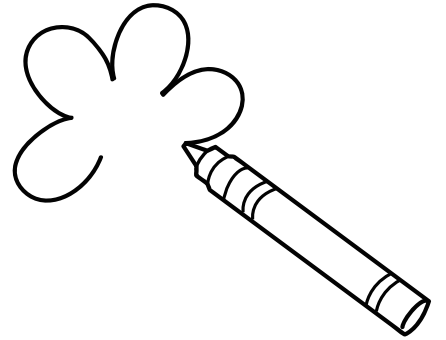

③

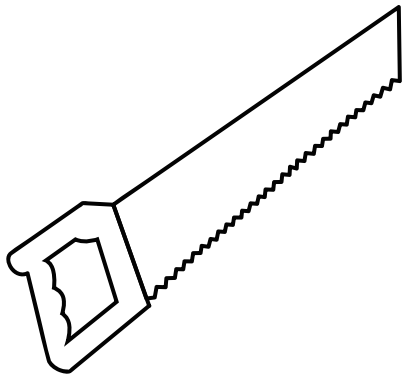

①

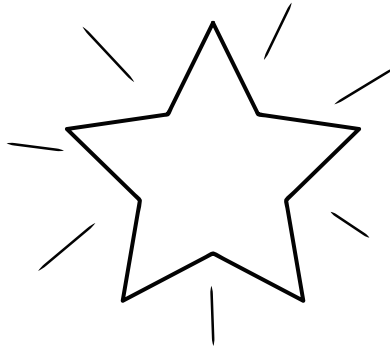

②

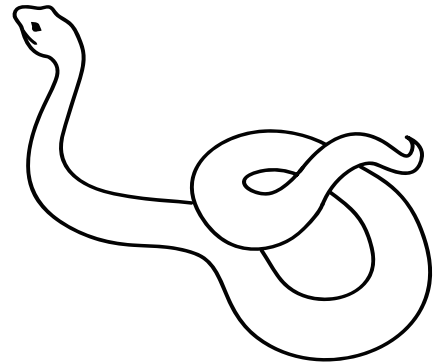

③

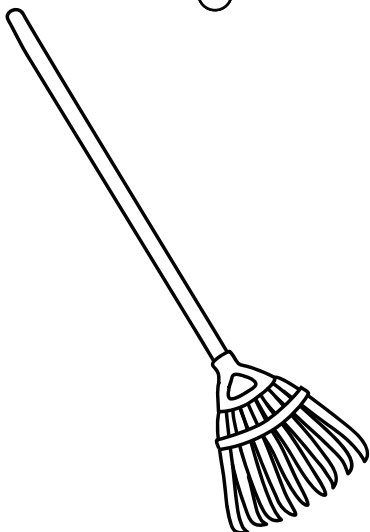

①

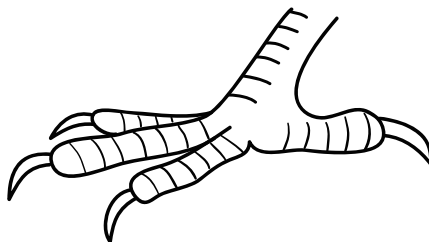

②

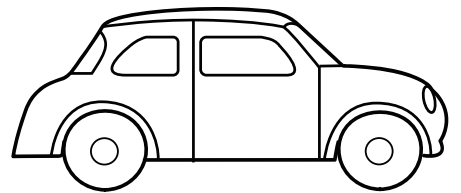

③



①

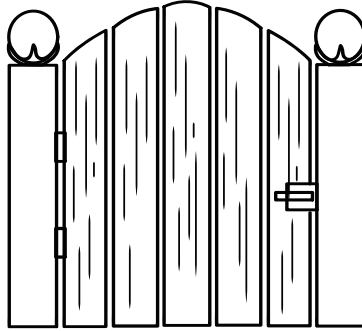

②

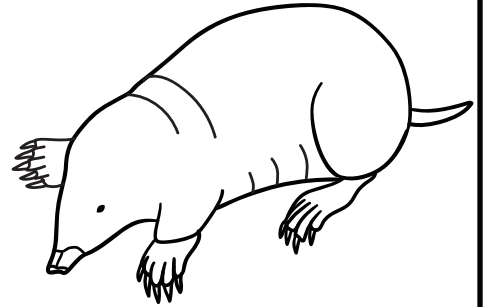

③

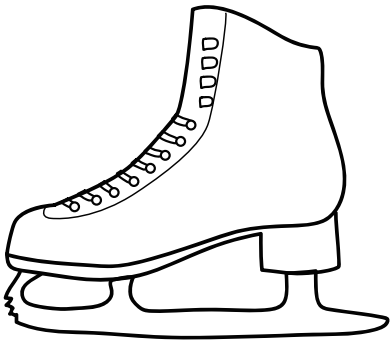

①

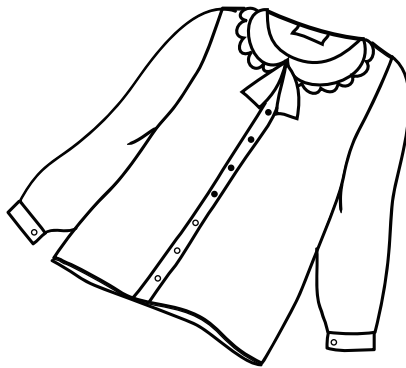

②

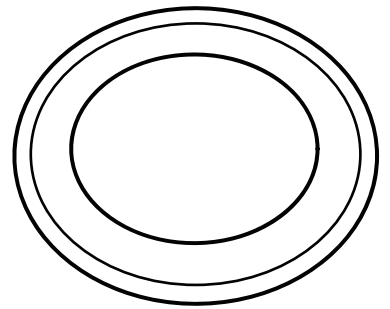

③



①

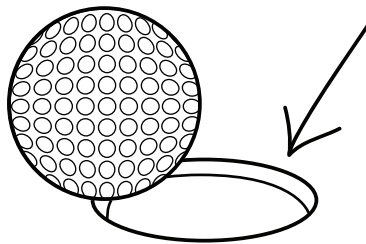

②



③