

3-Letter Word Puzzle Cards

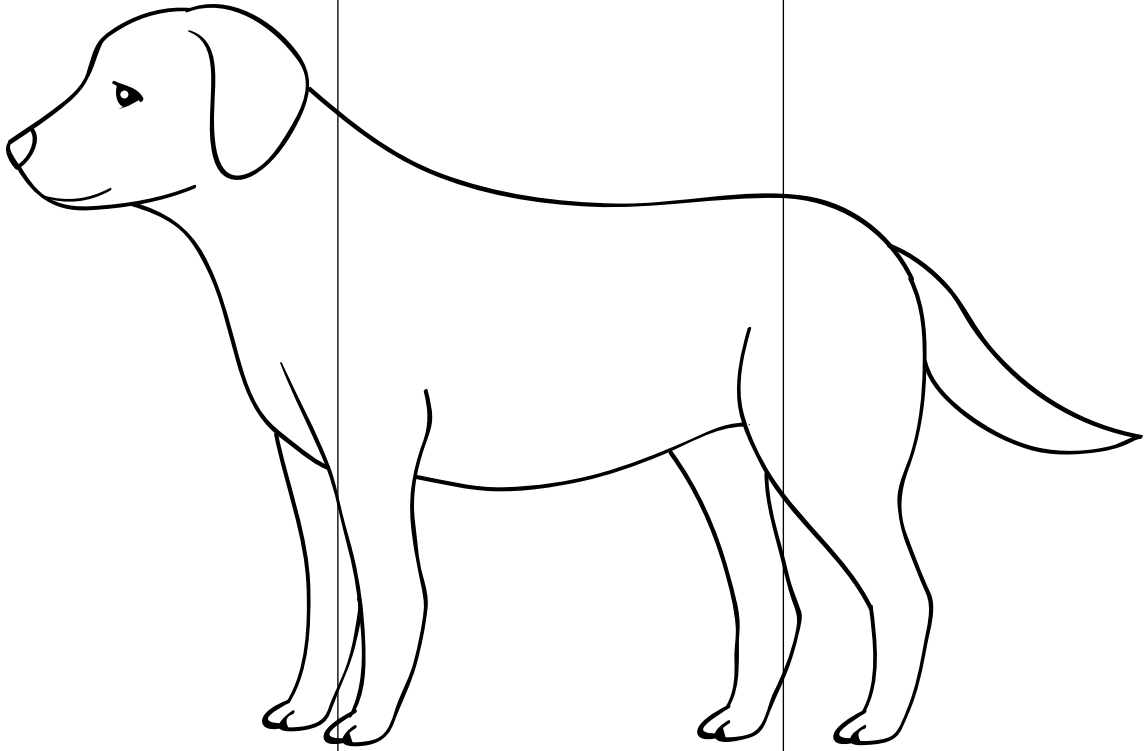

d

o

g

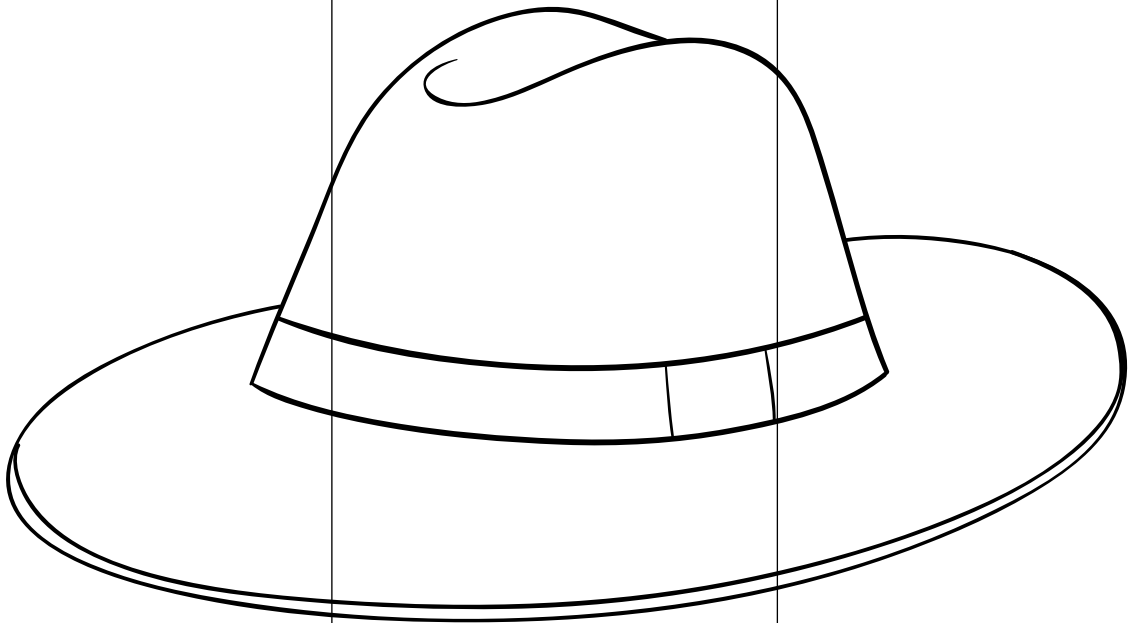

h

a

t

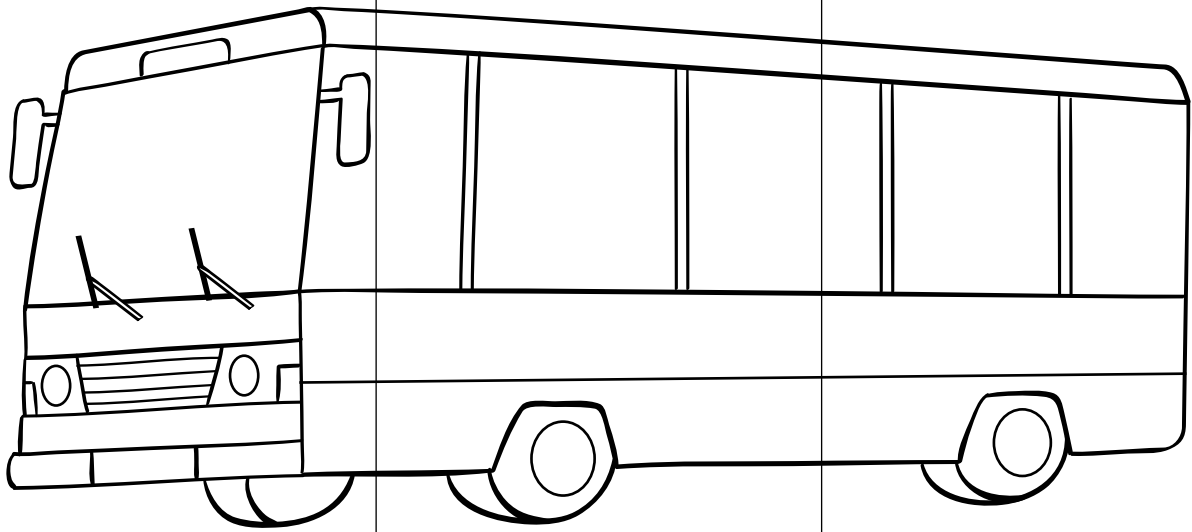

b

u

s

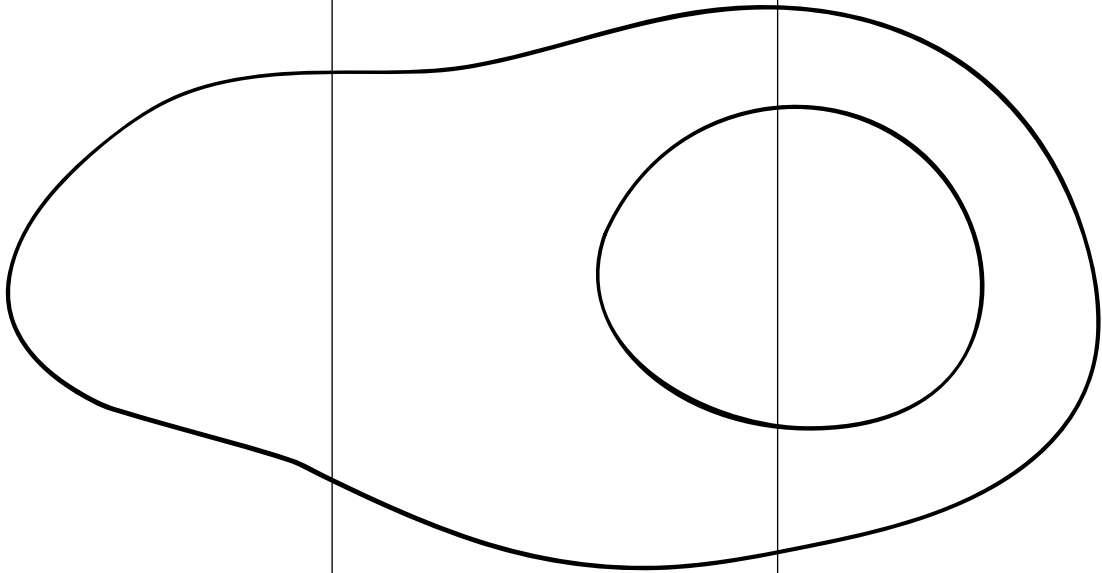

e

g

g

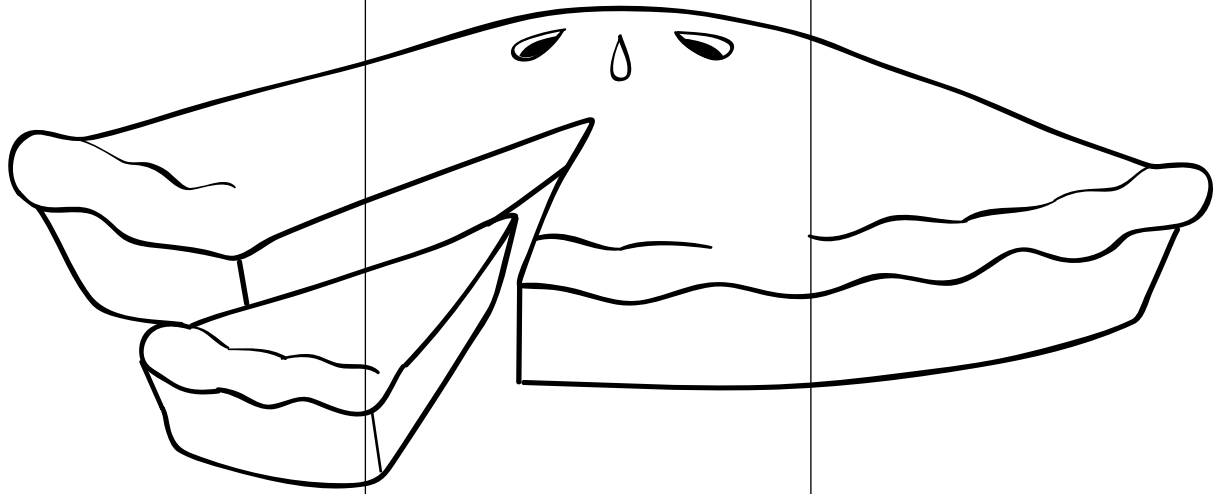

p

i

e

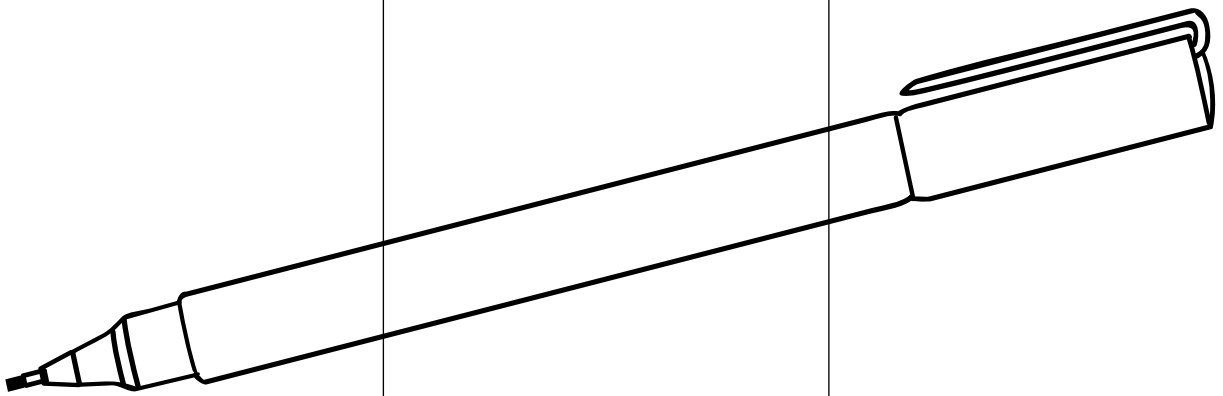

p

e

n

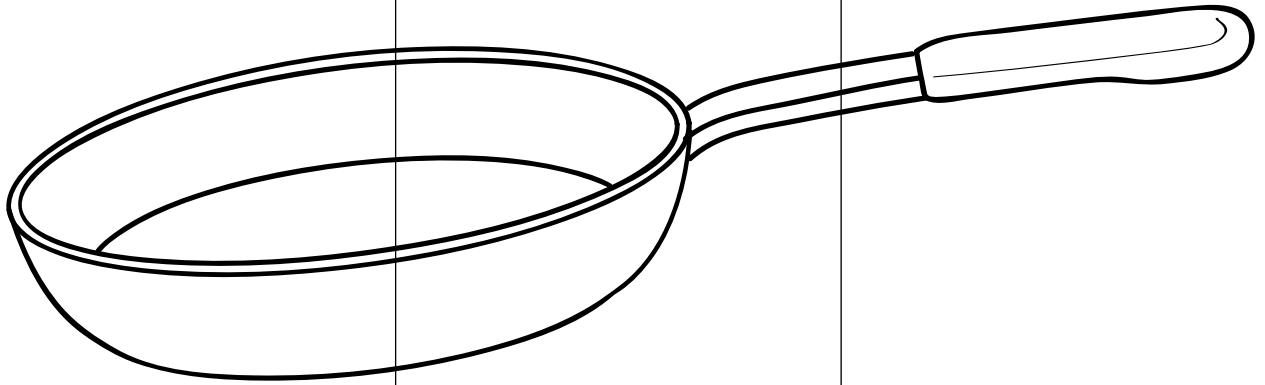

p

a

n

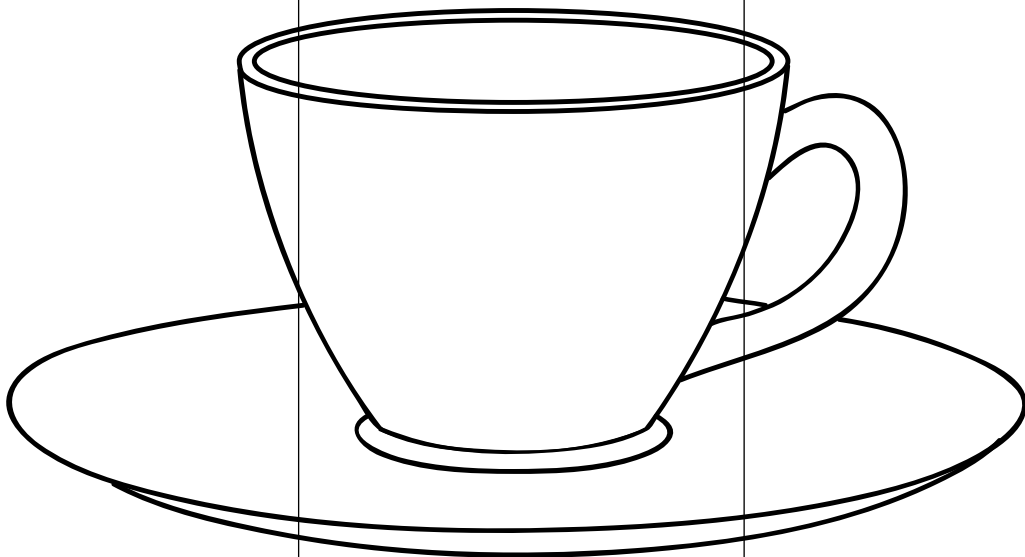

c

u

p

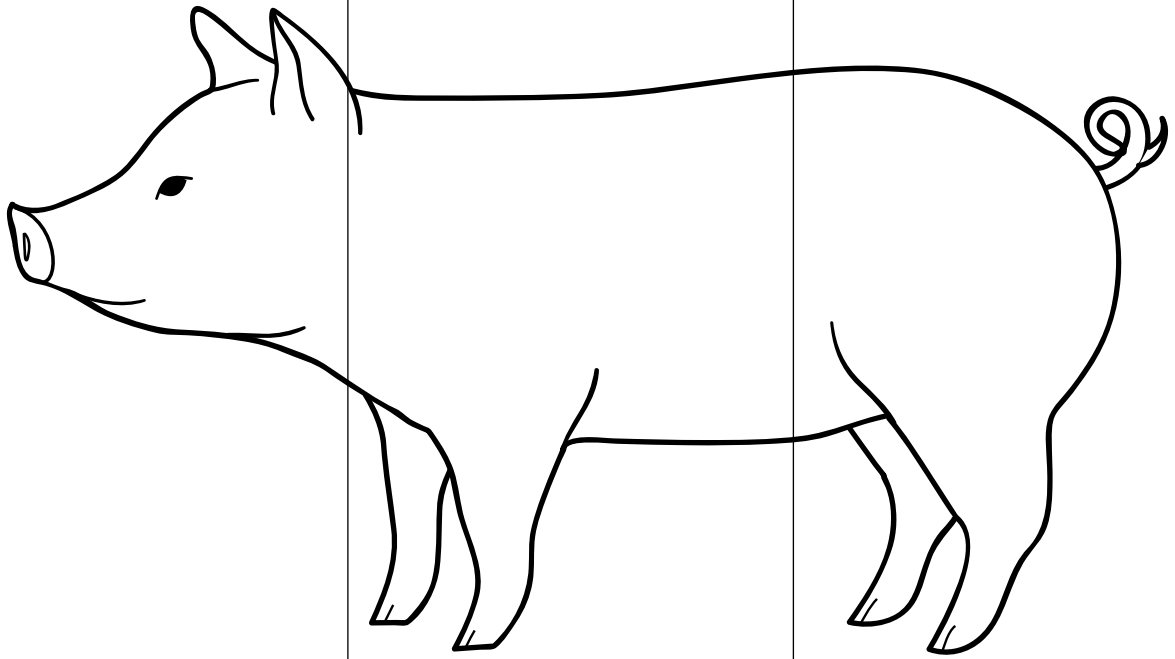

p

i

g

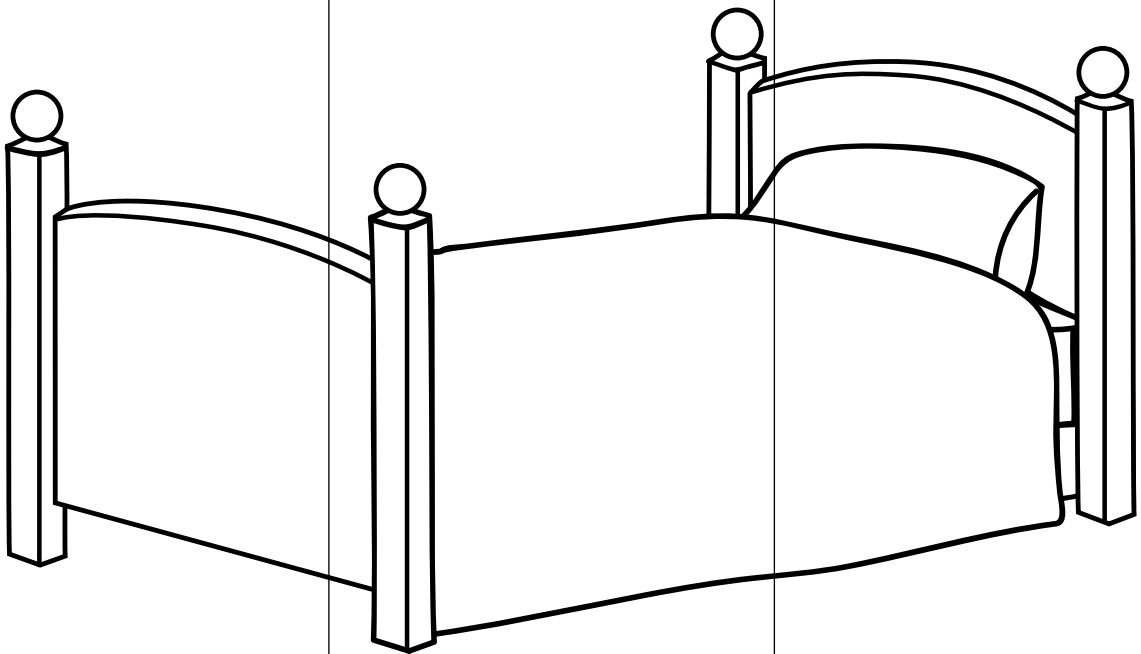

b

e

d

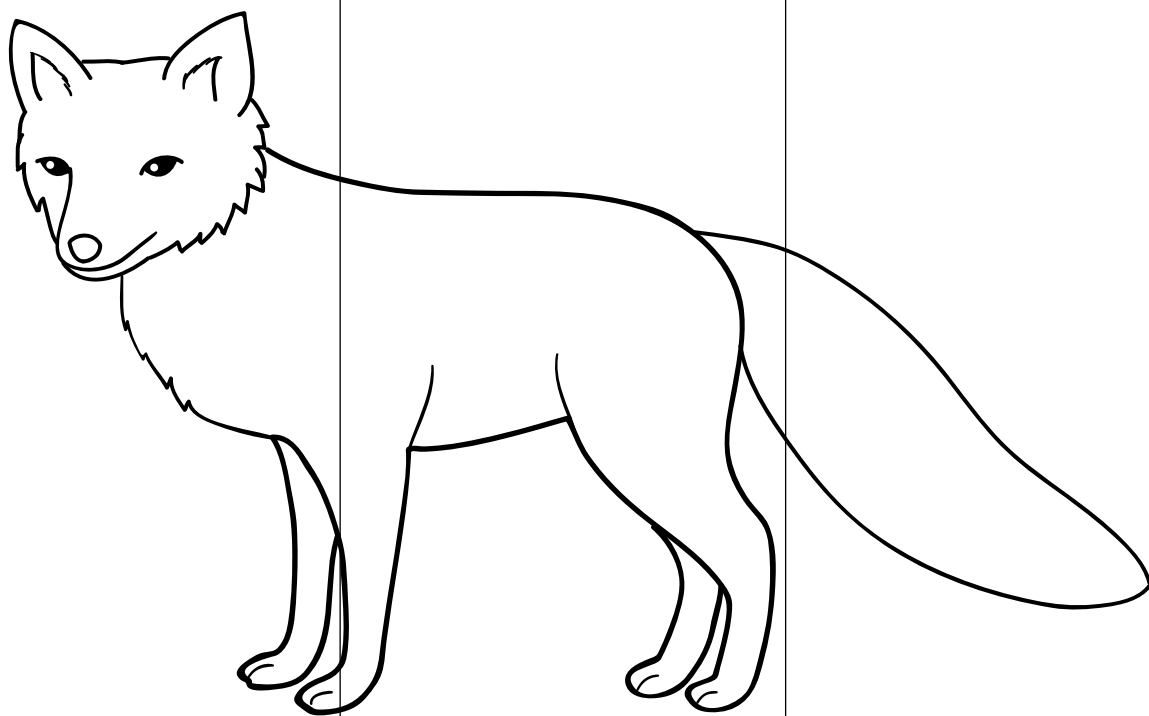

f

o

x

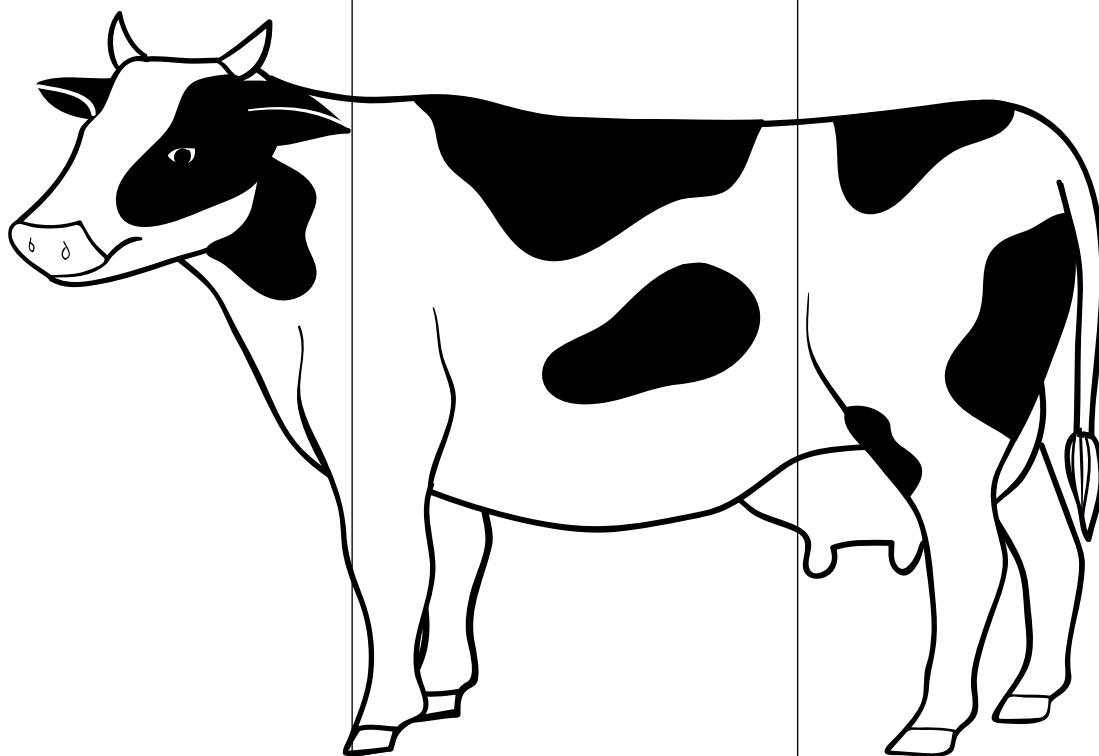

c

o

w

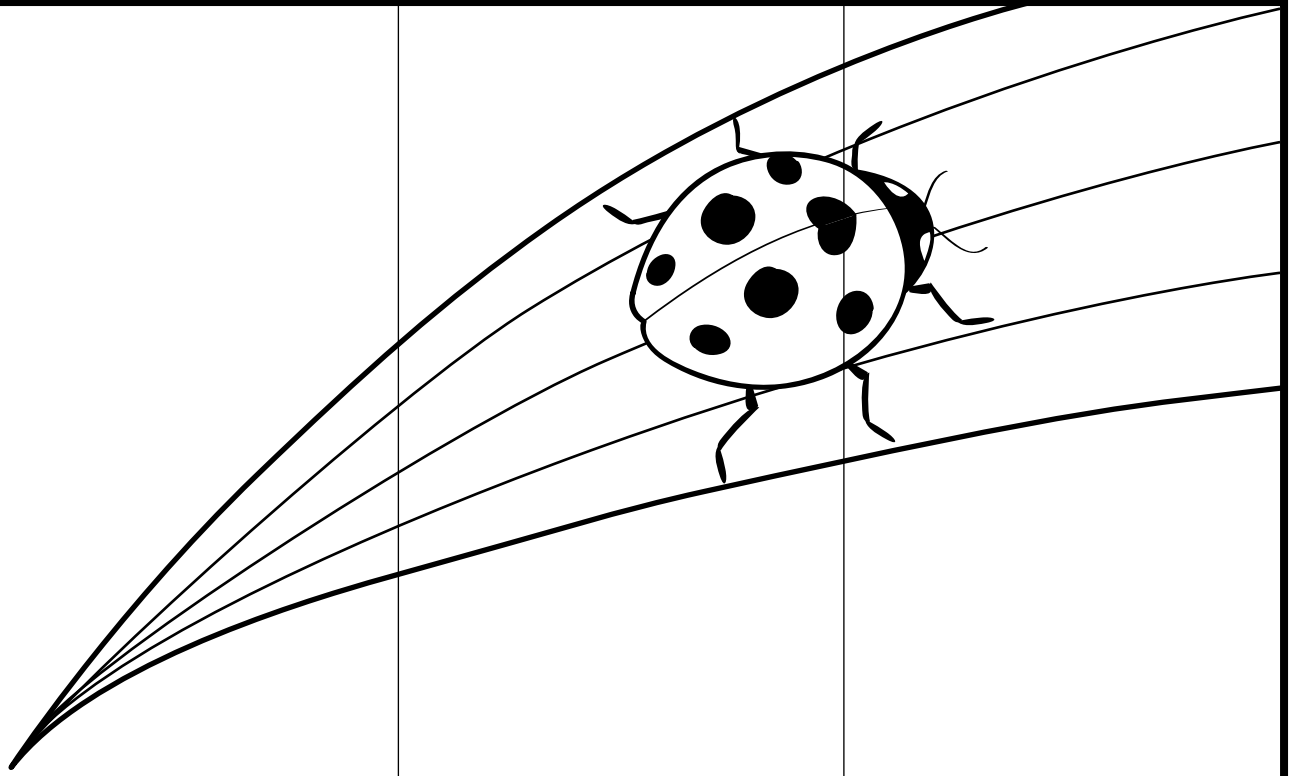

b

u

g

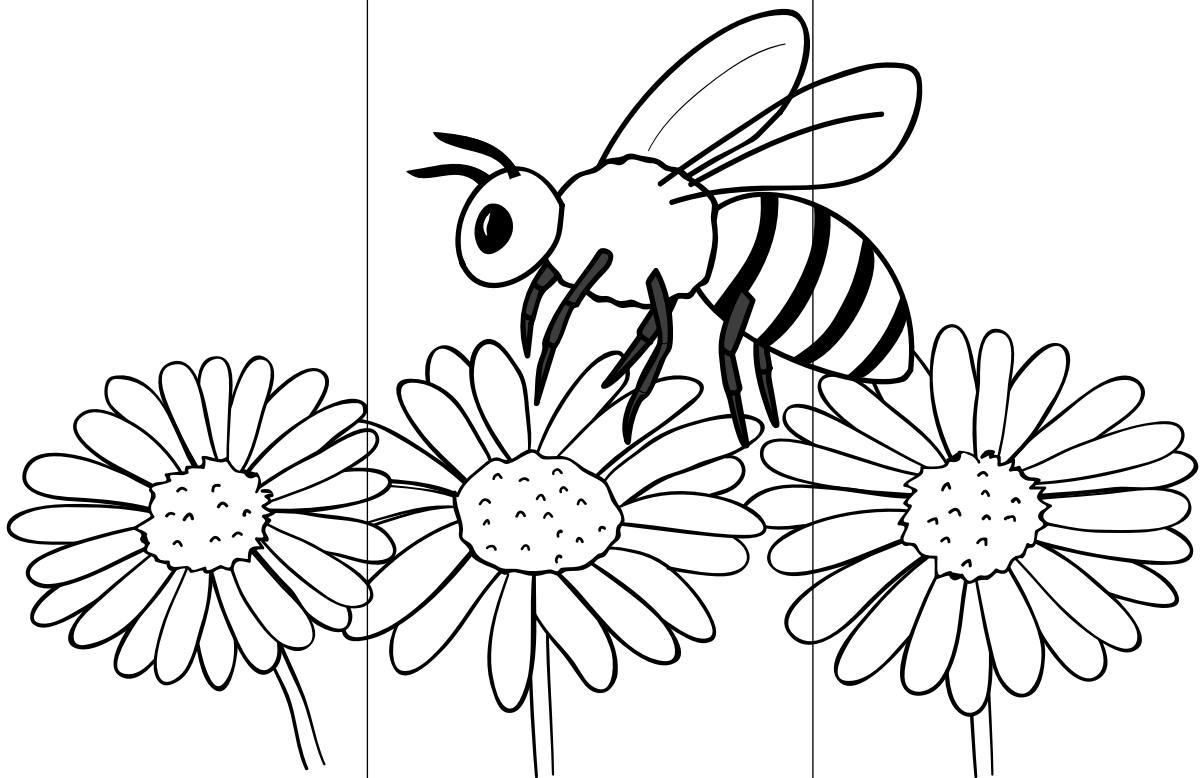

b

e

e

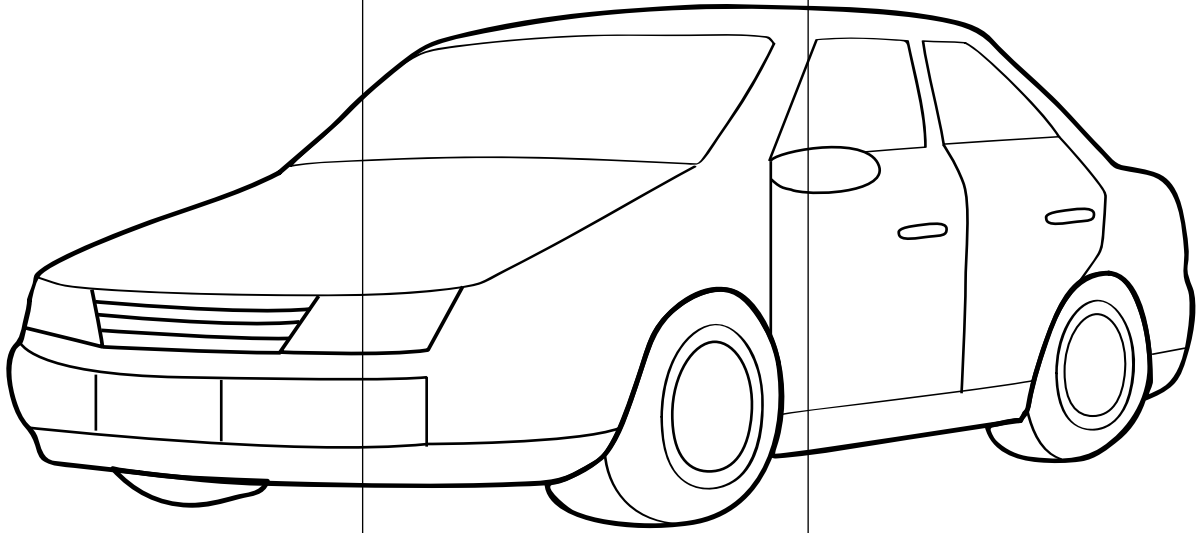

c

a

r

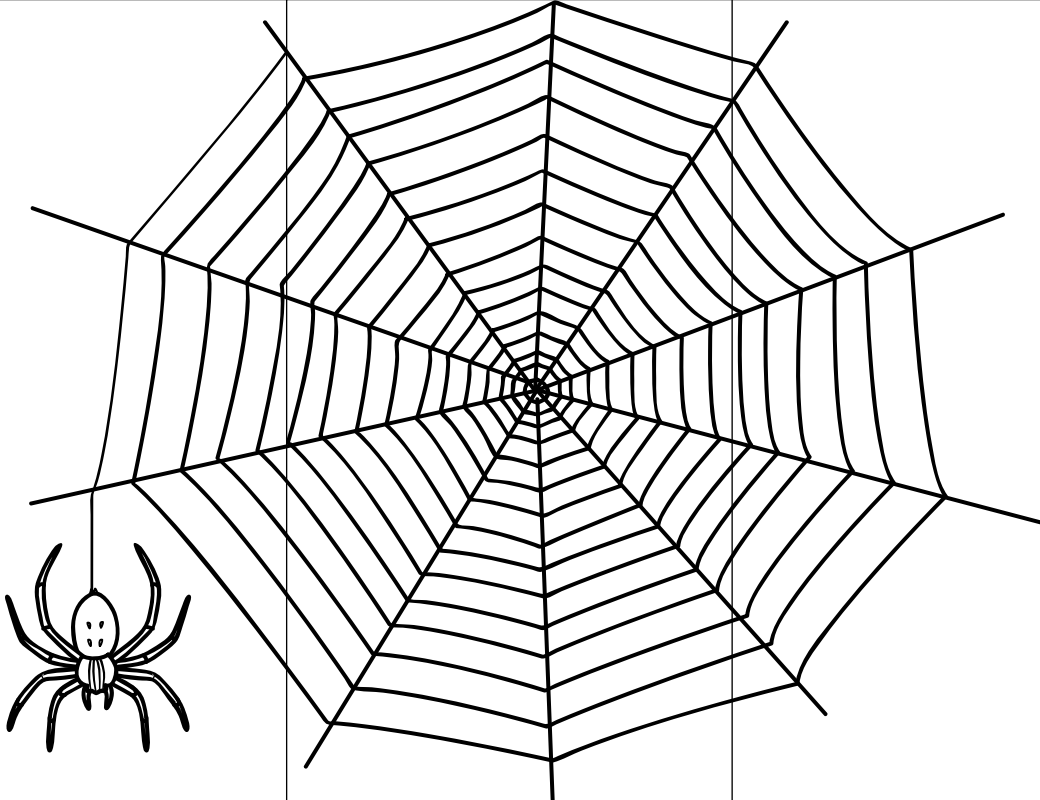

w

e

b