

# Phonics Word Wheel: Digraphs

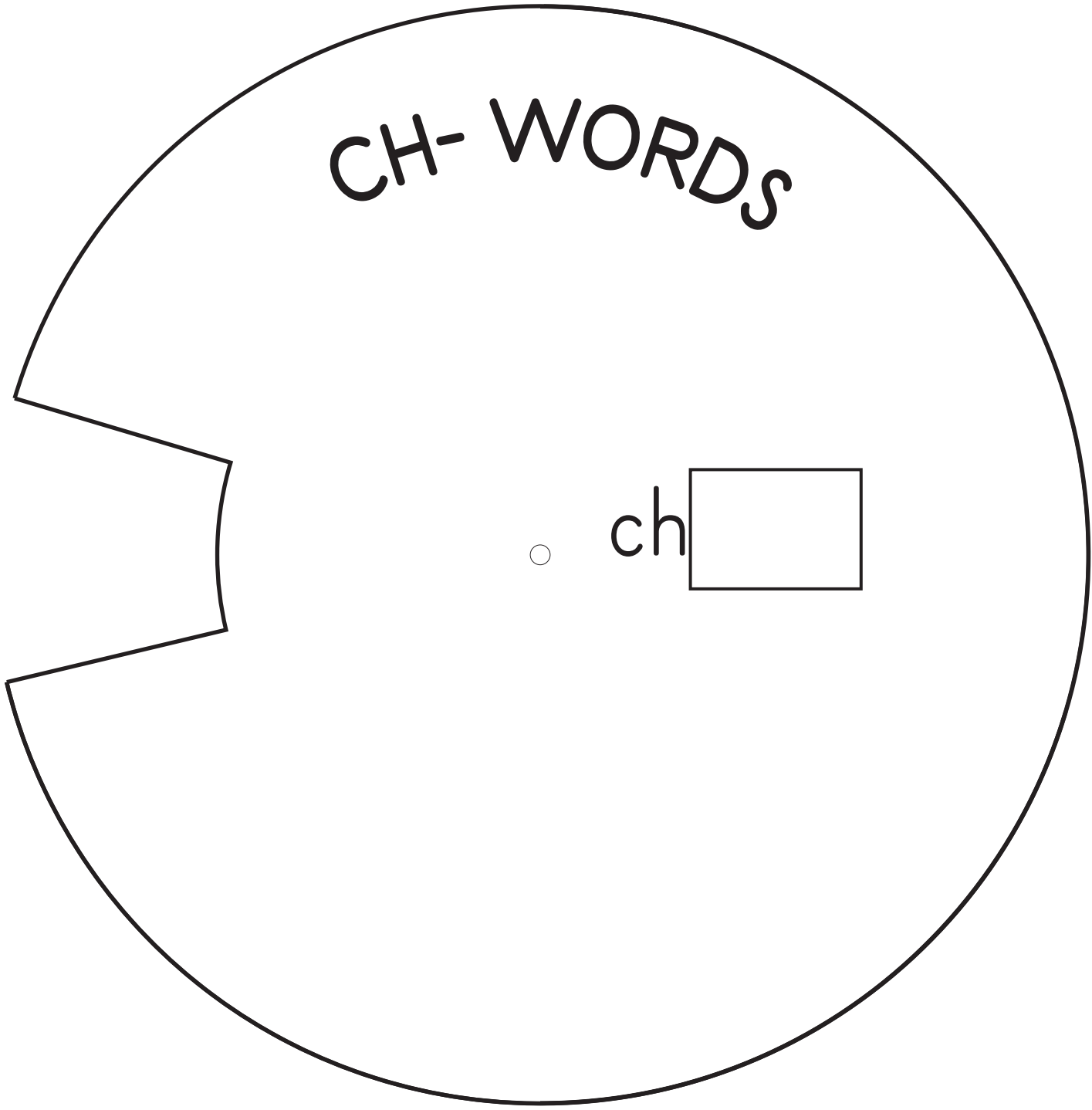

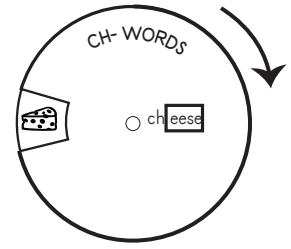

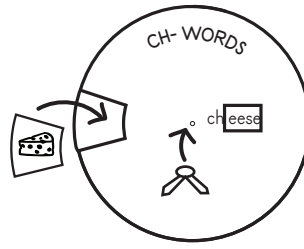

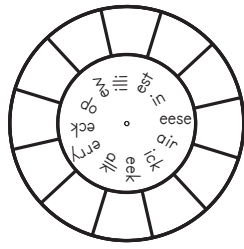
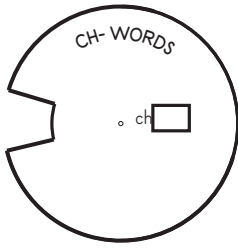
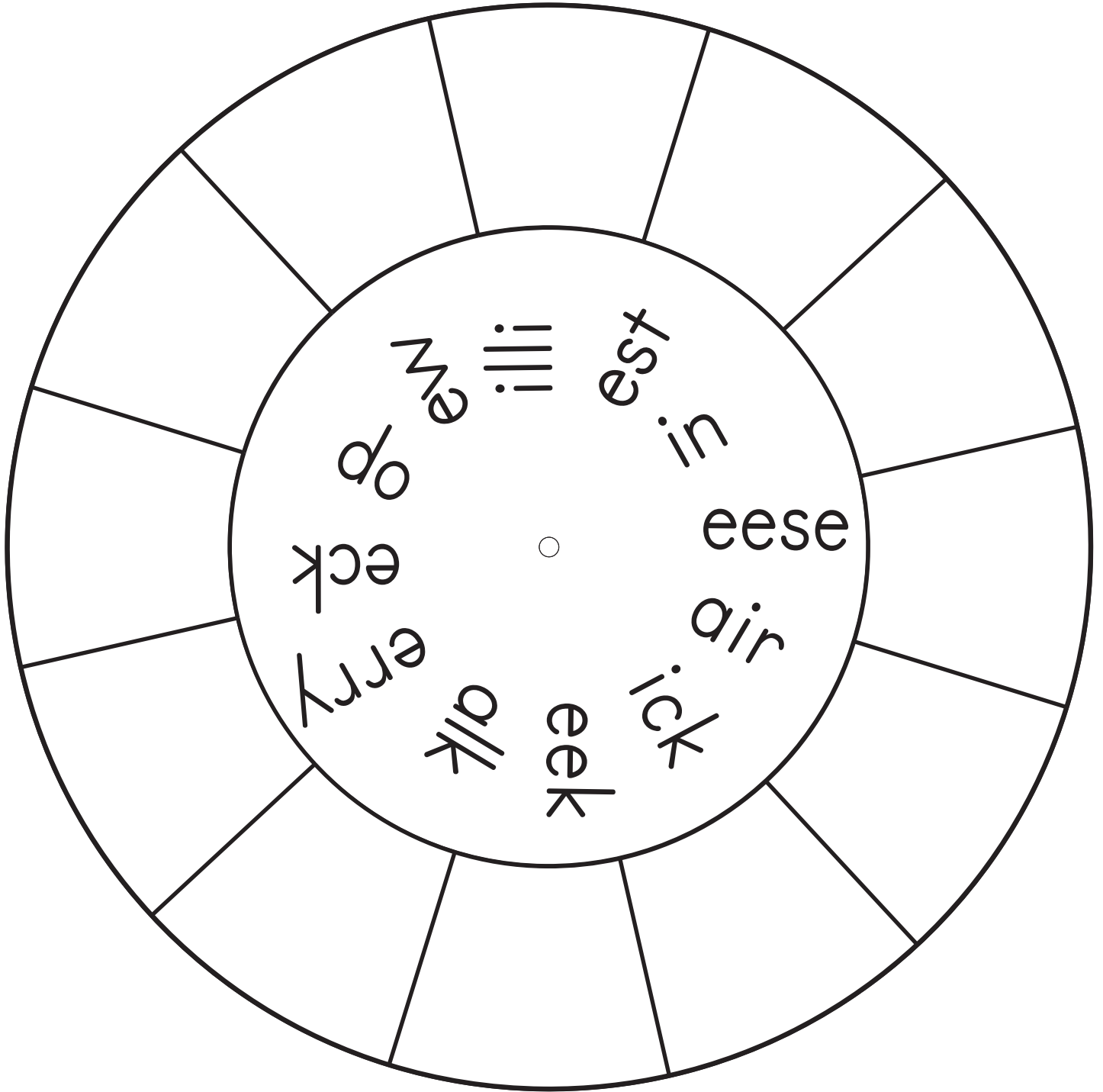
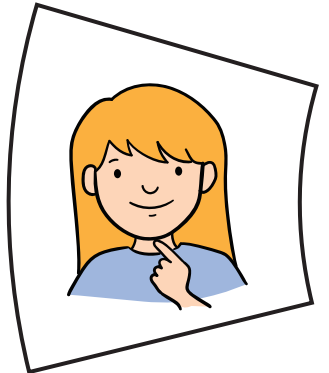
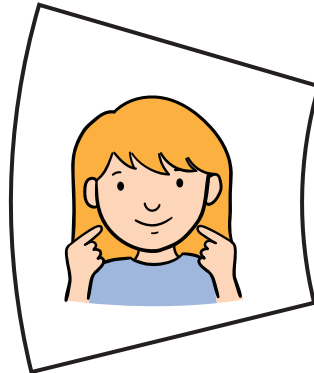
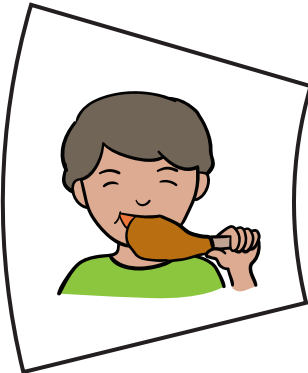
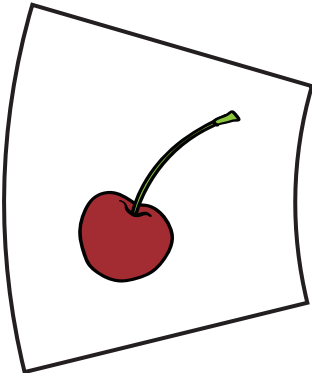
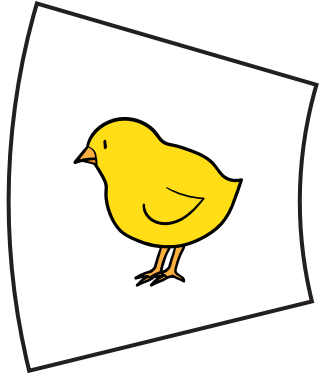
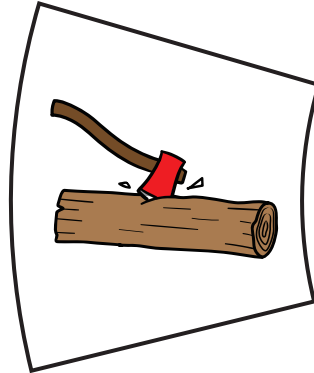
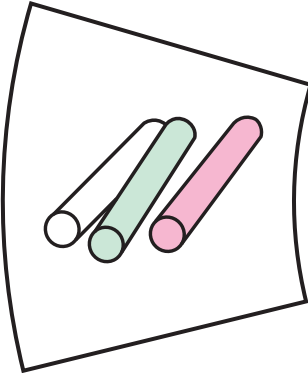
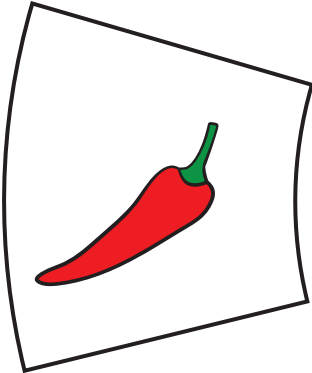
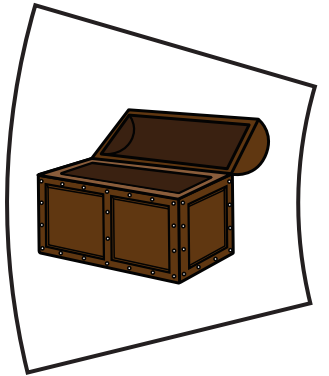
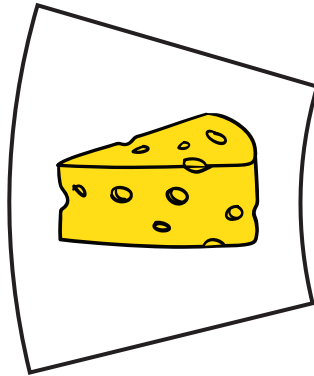
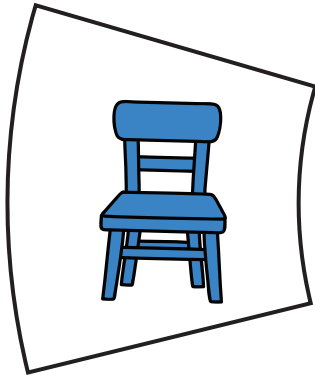
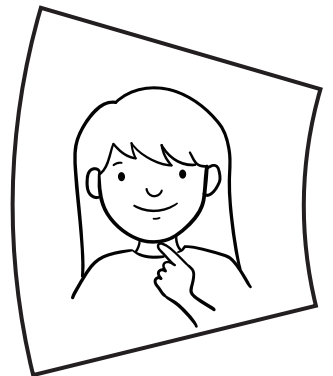
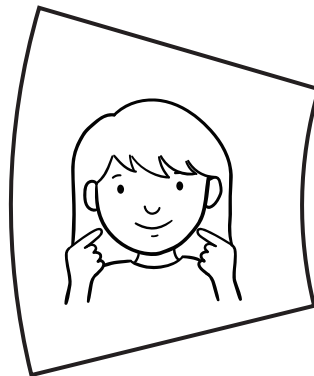
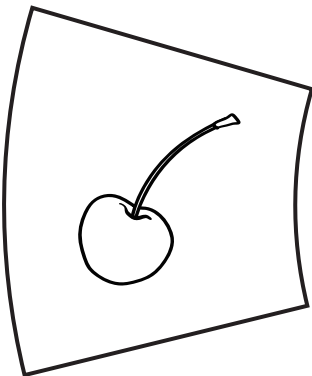
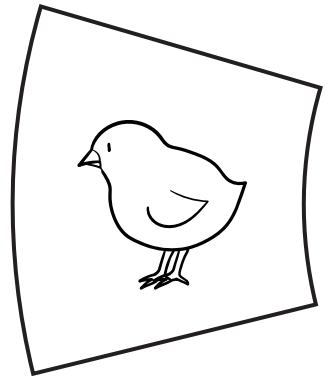
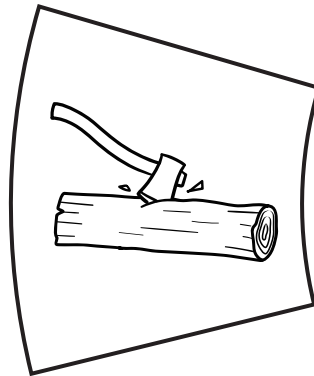
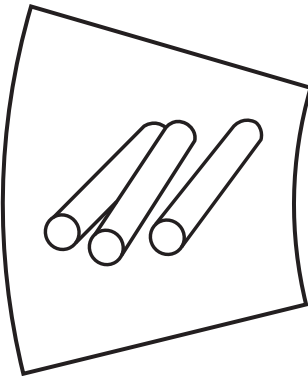
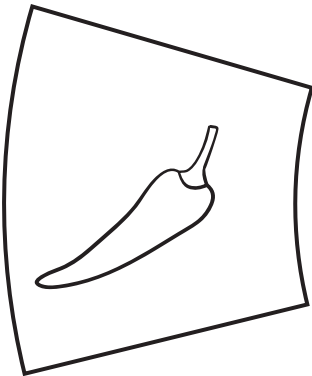
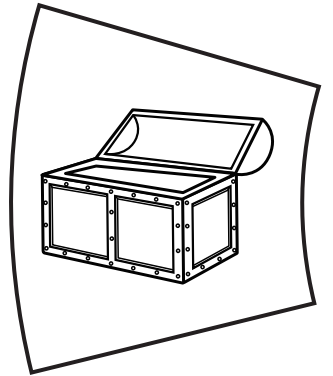
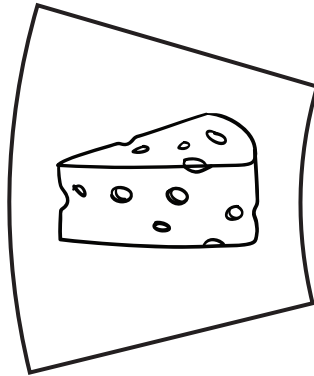
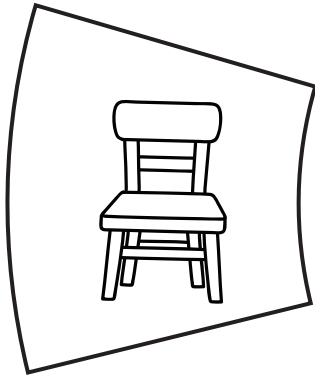
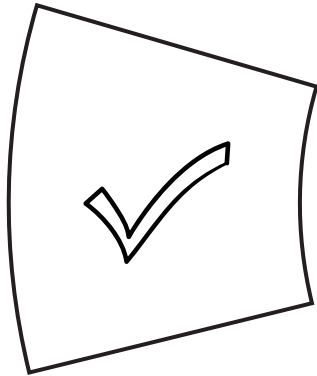

# -CH WORDS

○

ch

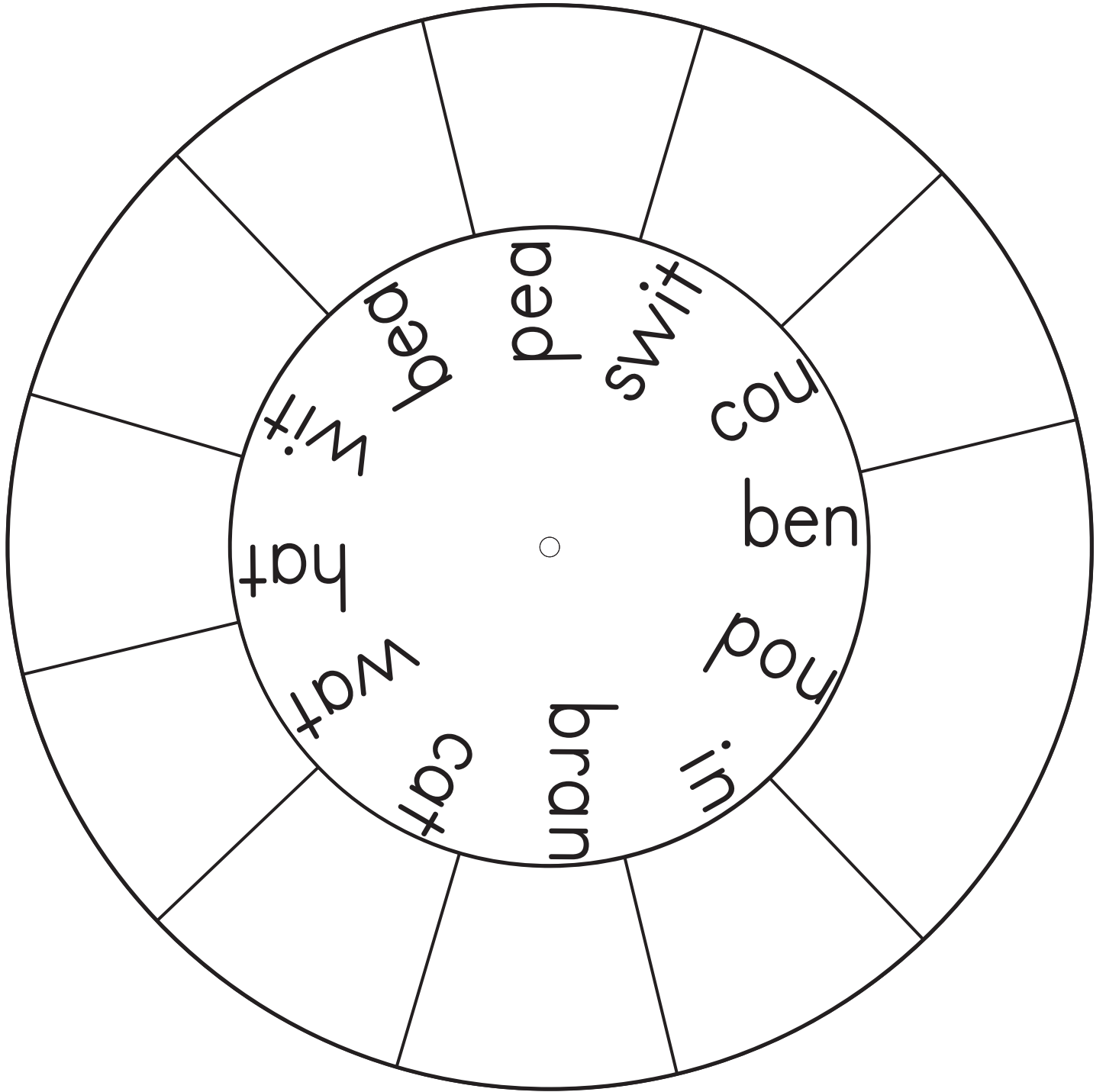

ped  
swims  
cou  
ben  
pod  
in  
bran  
cat  
wat  
hat  
wit

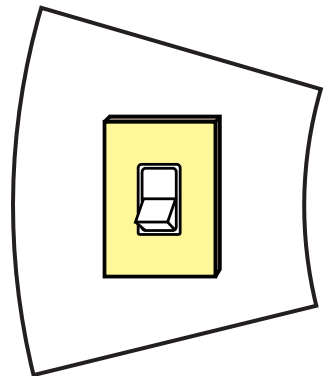
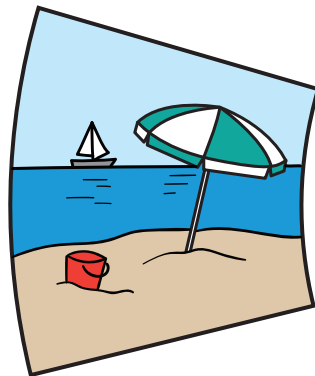
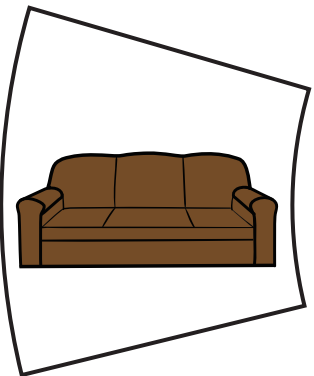
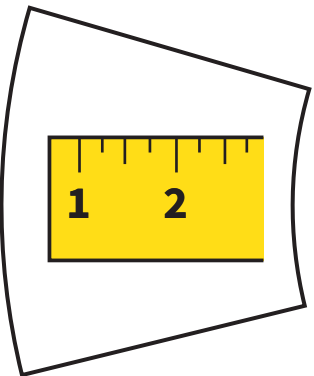
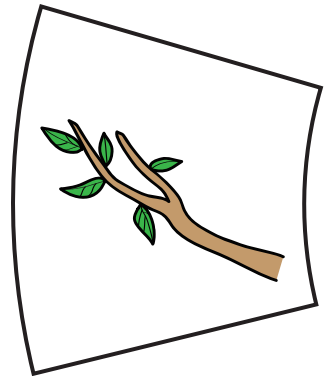
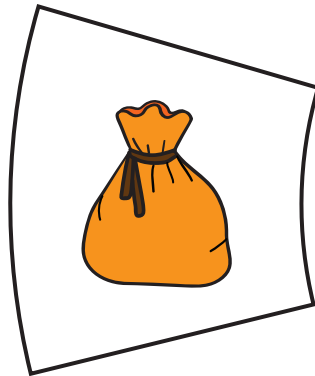
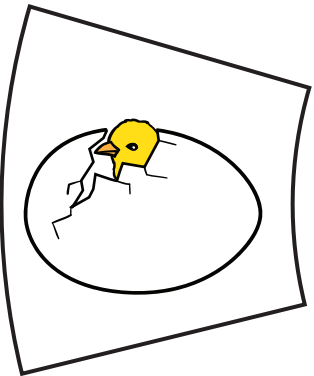
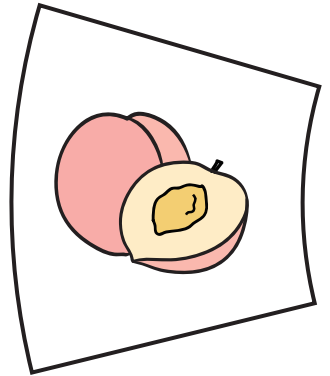
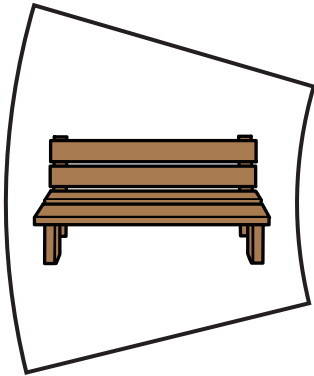
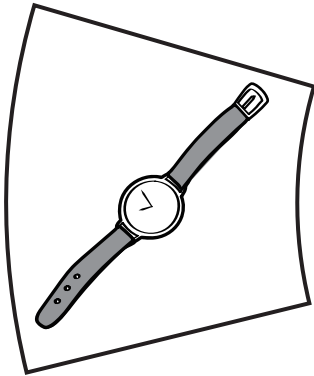

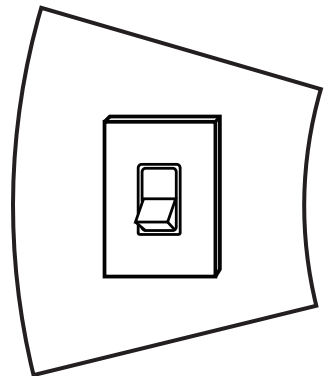
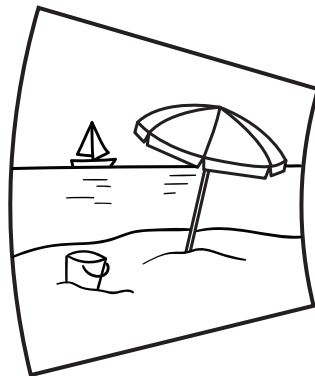
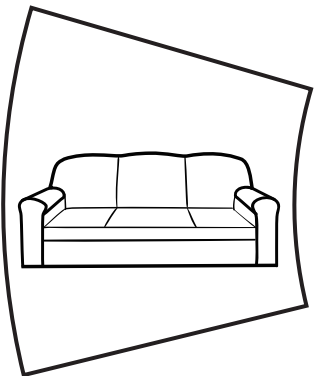
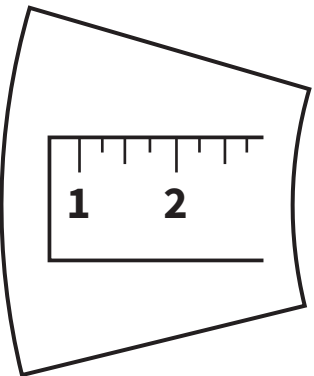
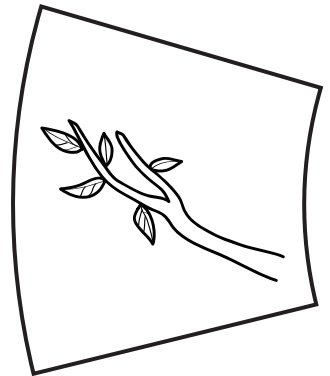
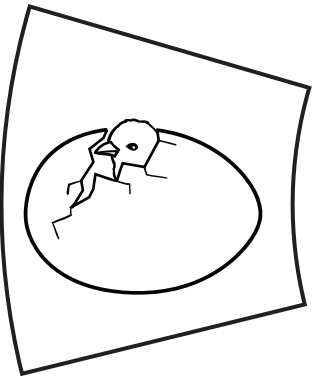
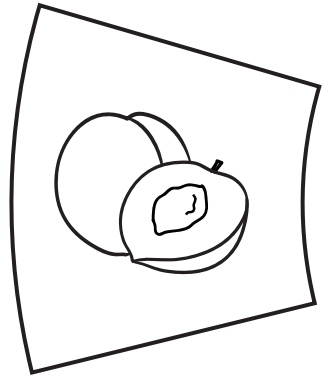
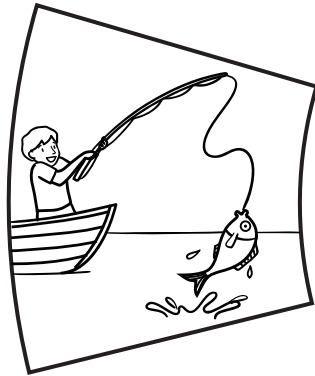
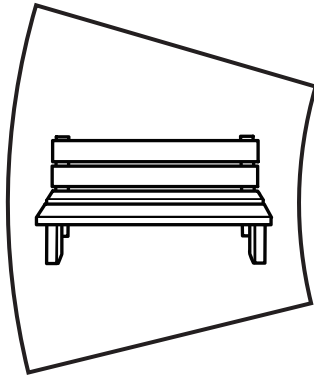
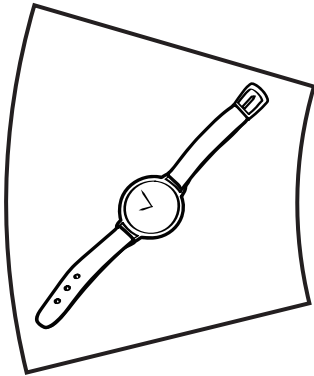



# Phonics Word Wheel: Digraphs

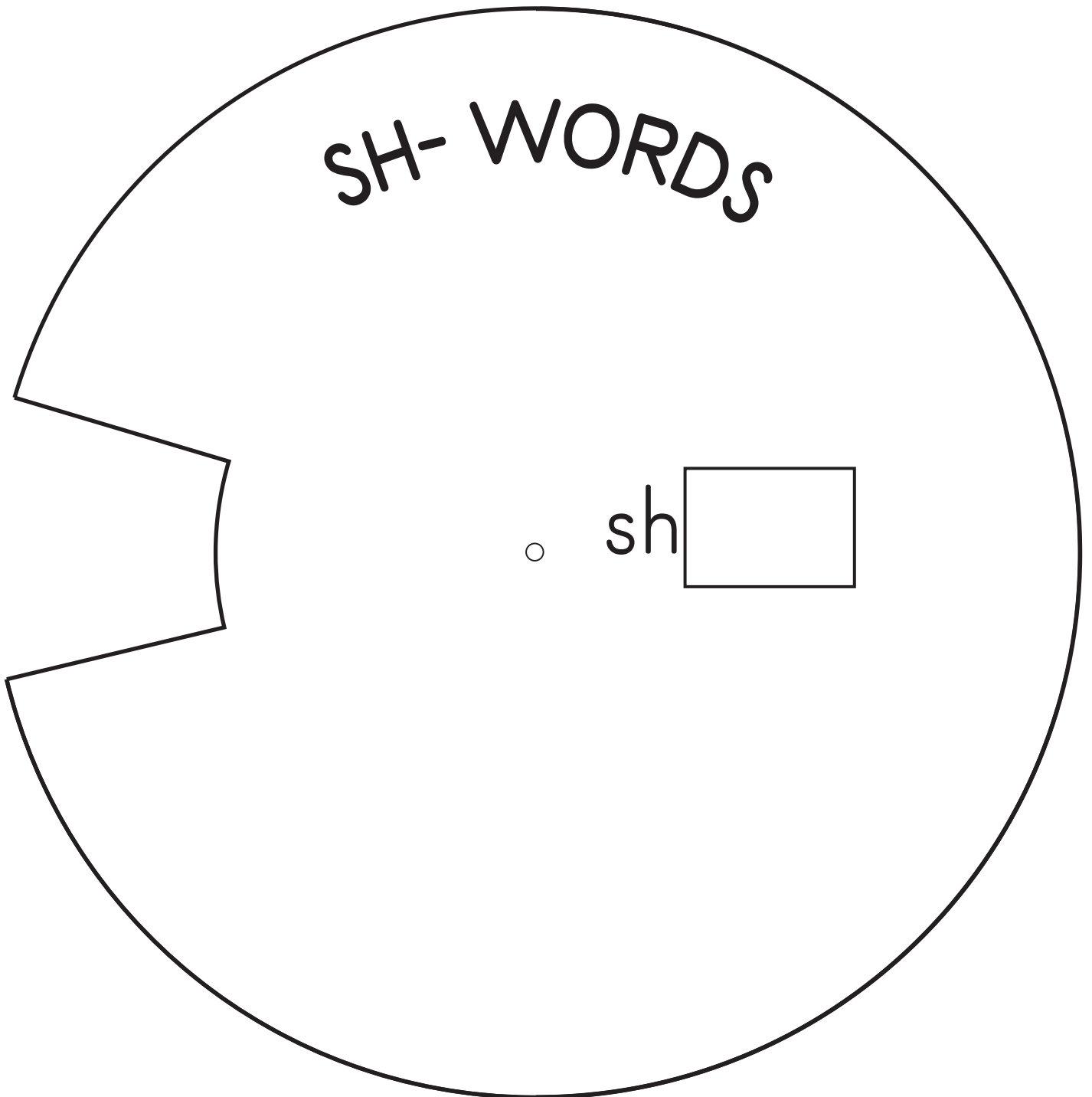
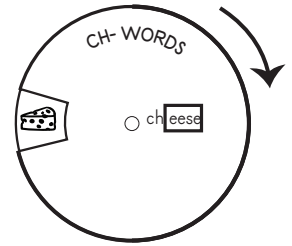
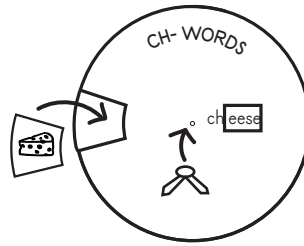
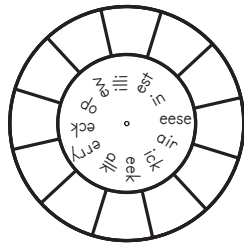
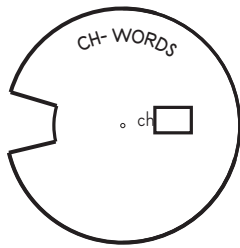

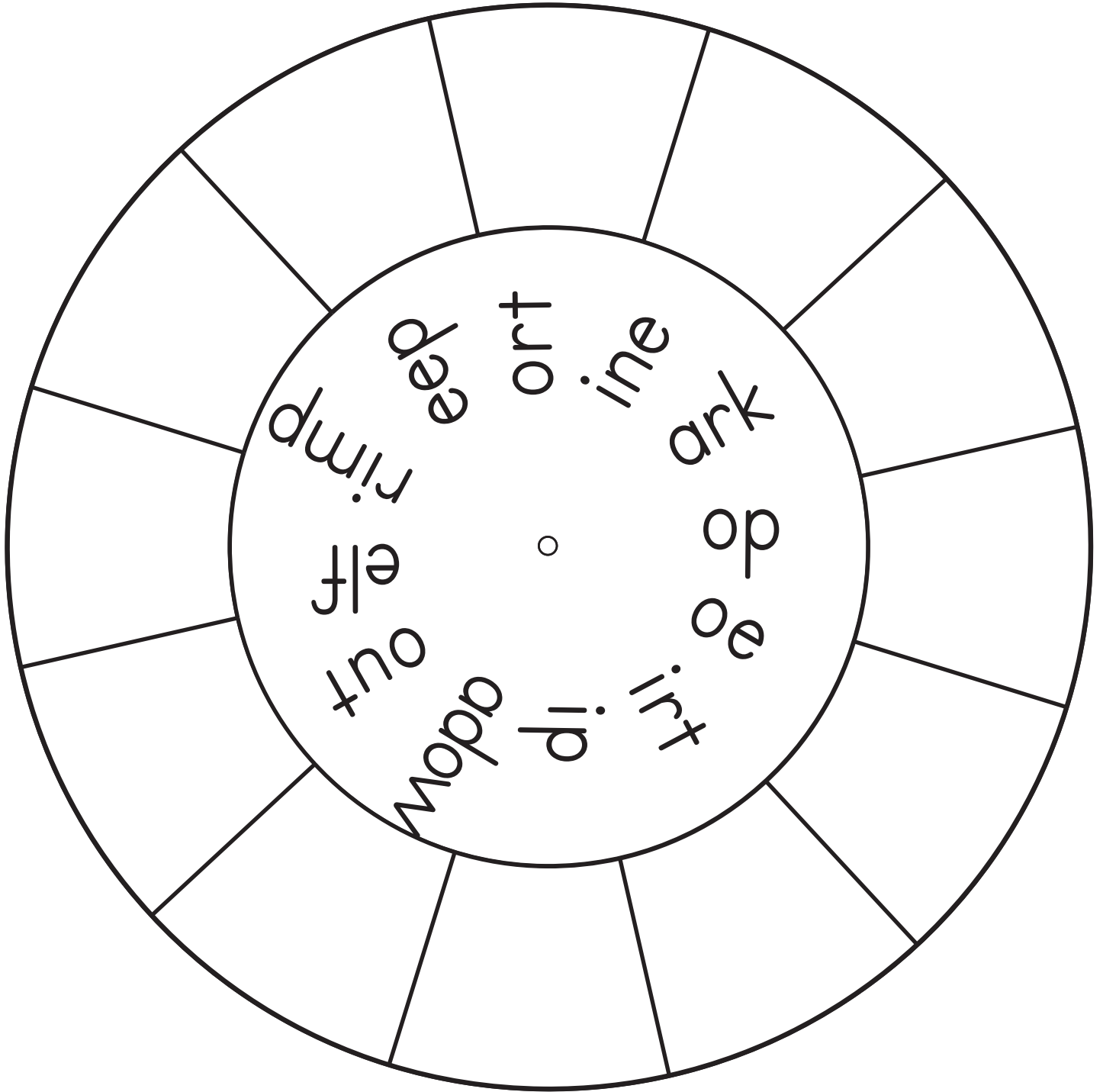

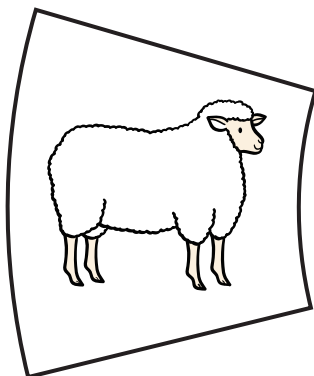
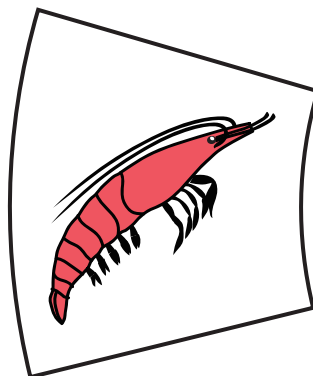
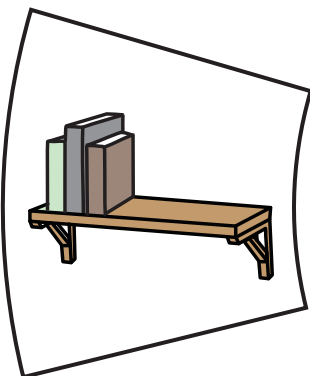
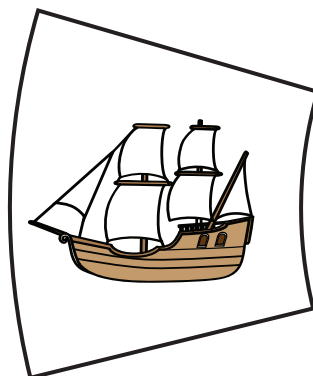
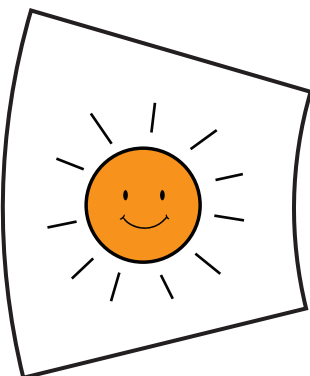
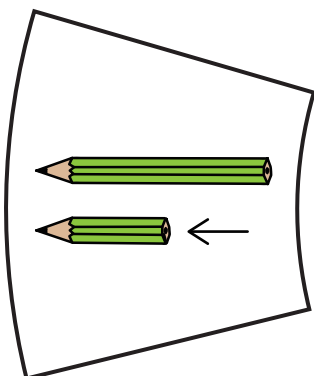
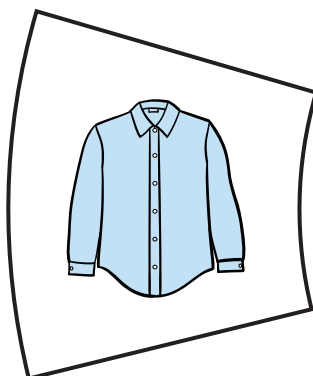
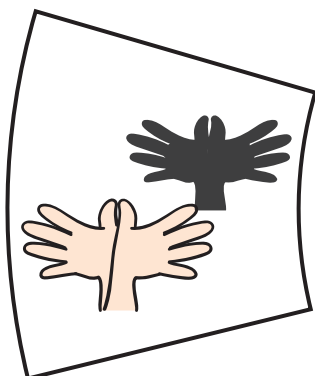
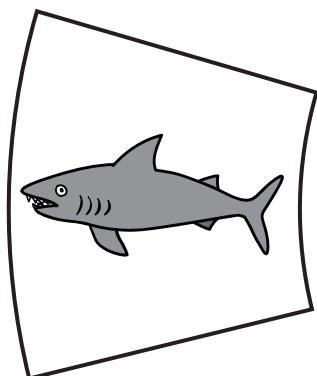

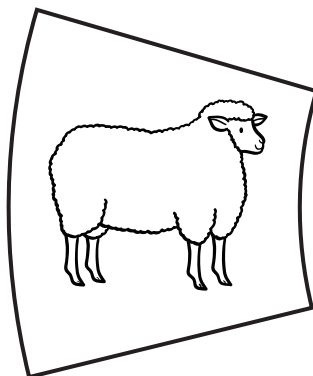
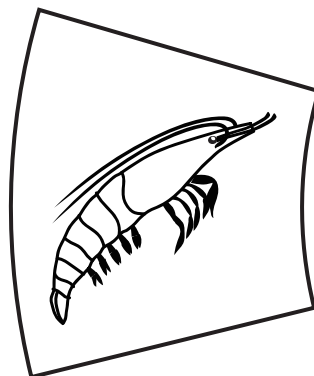
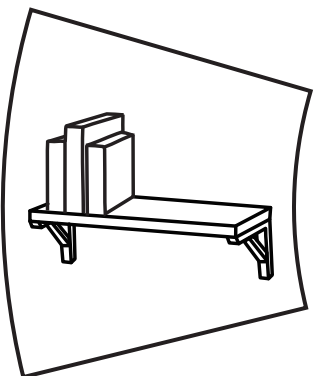
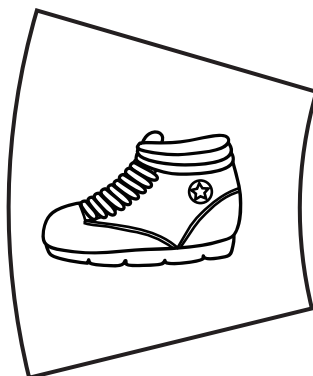
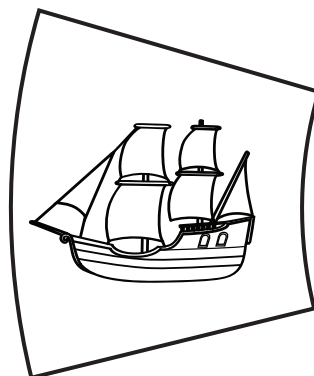
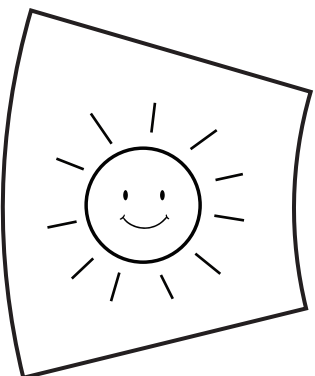
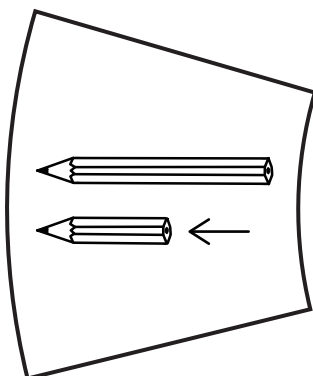
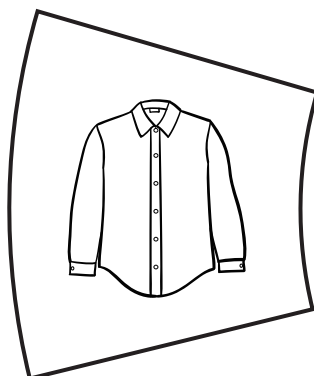
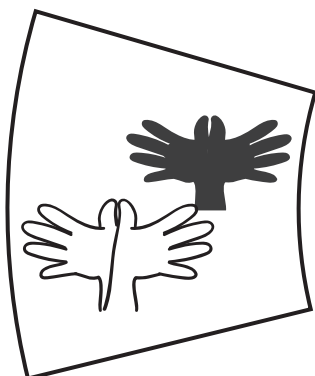
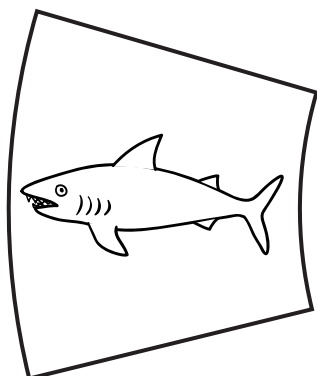

# -SH WORDS

o



sh

