

Word Family Worm(I): -uck

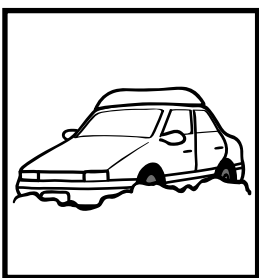

Word Family Worm(I): -uck

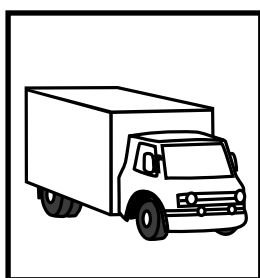
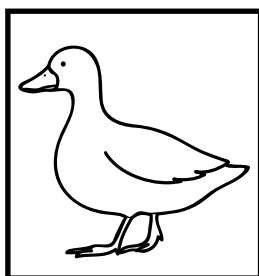
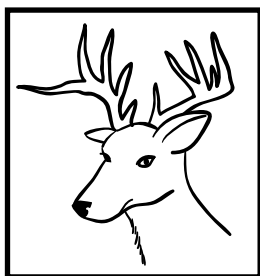
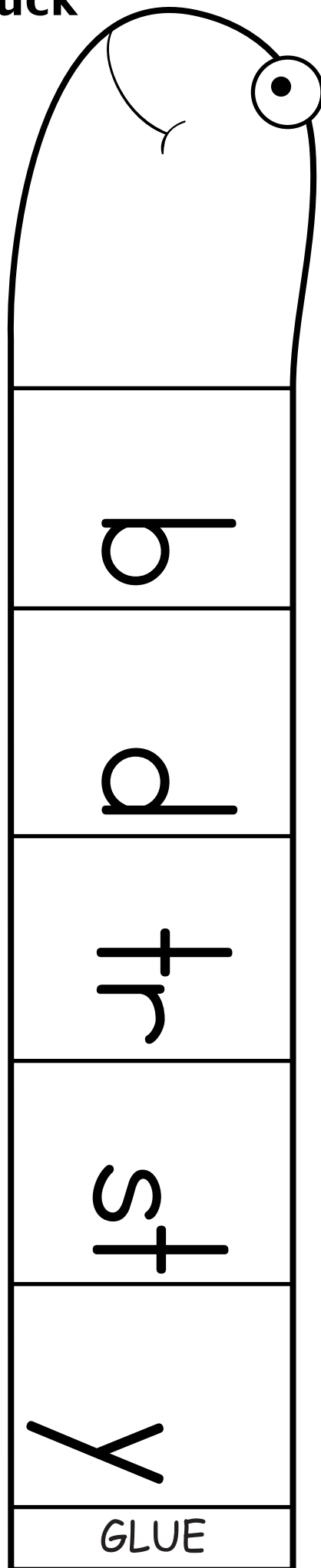
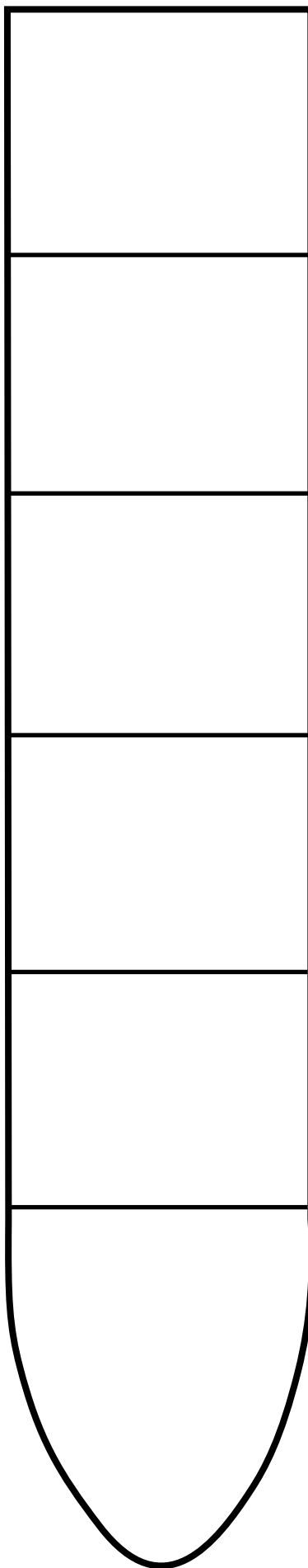
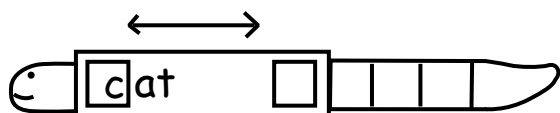
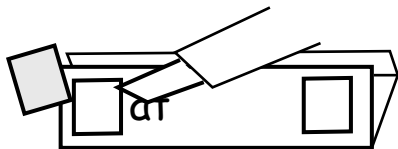
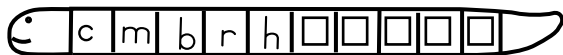
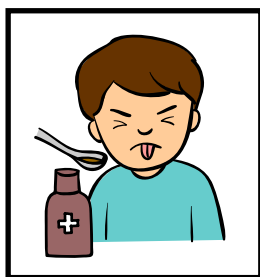
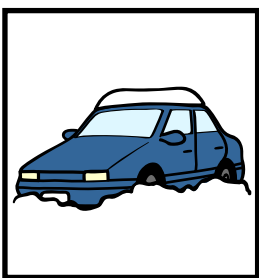
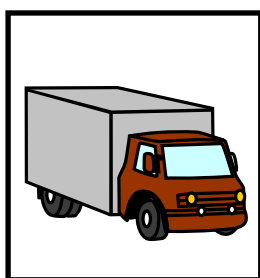
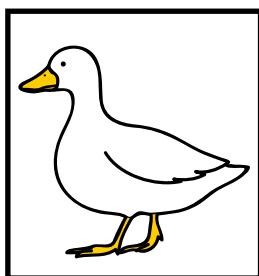
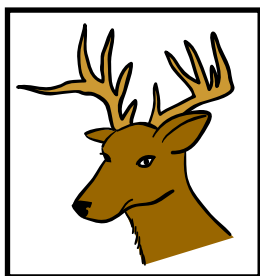
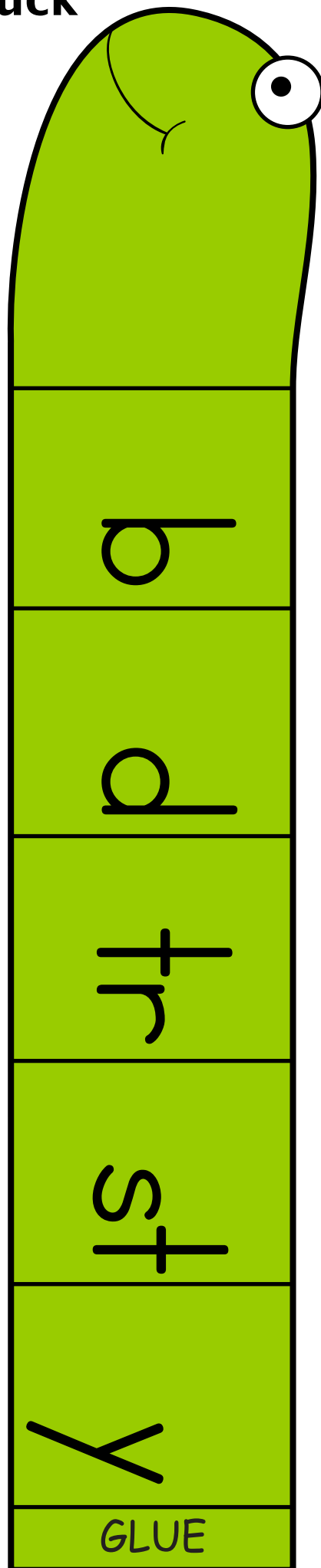
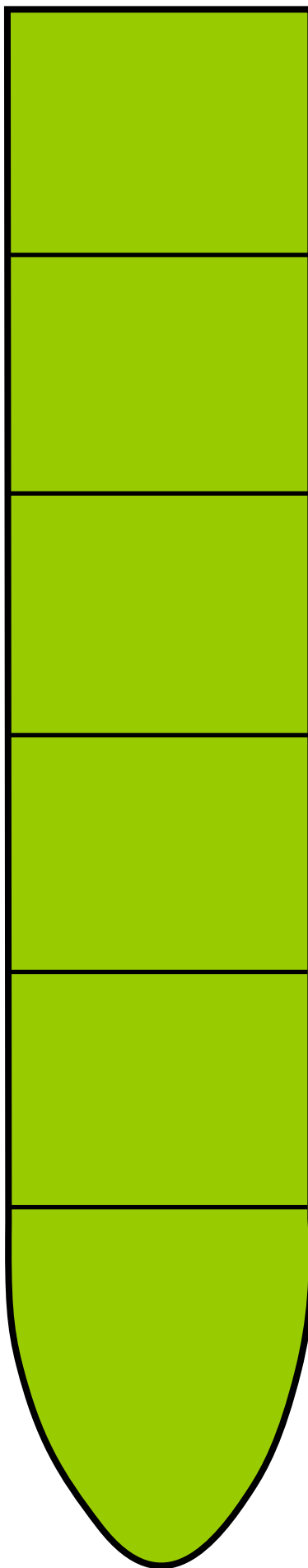
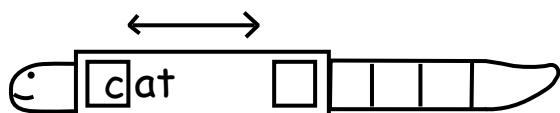
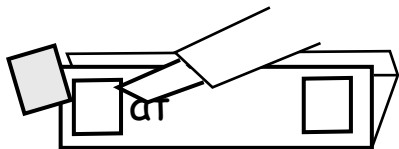
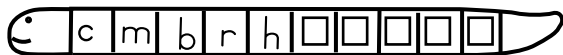

GLUE

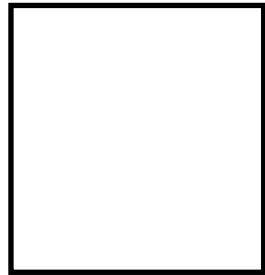

uck

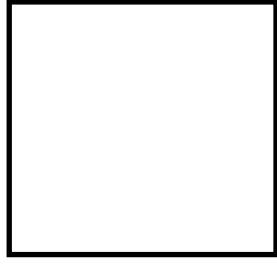

The -uck Family

____ uck

____ uck

____ uck

____ uck

____ uck

Word Family Worm(II): -uck

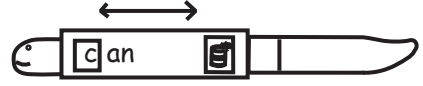

Cut slits on the -an card. Glue the worm strips together. Thread the worm through the slits on the card.

uck

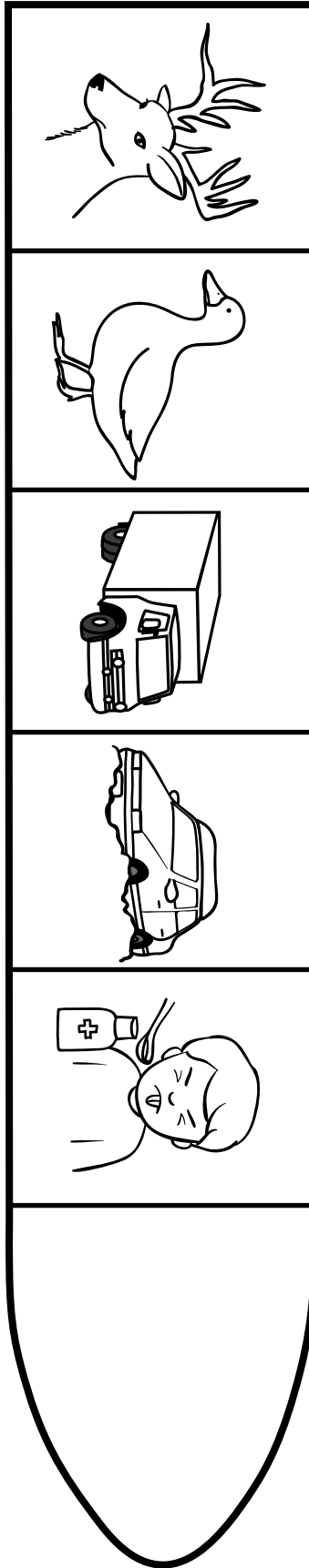

b
p
tr
st
Y
GLUE

Word Family Worm(I): -ug

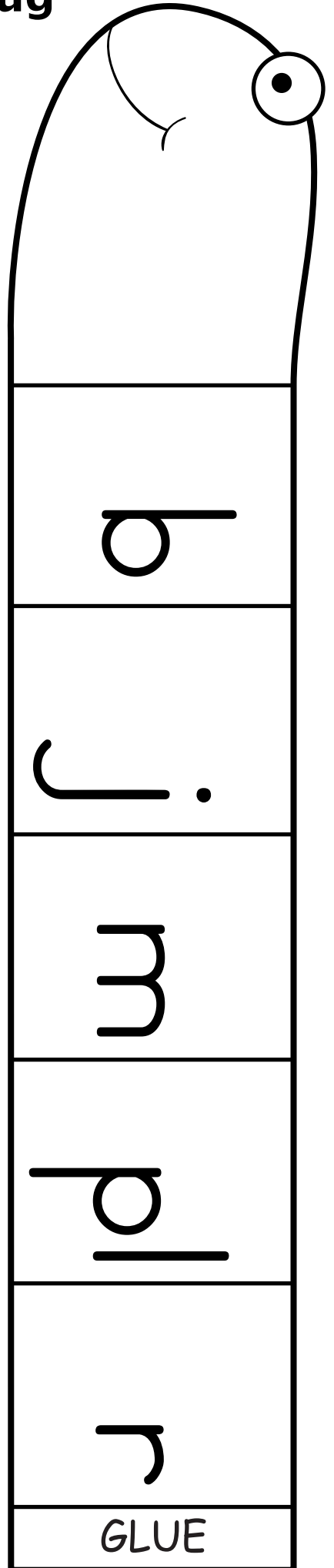
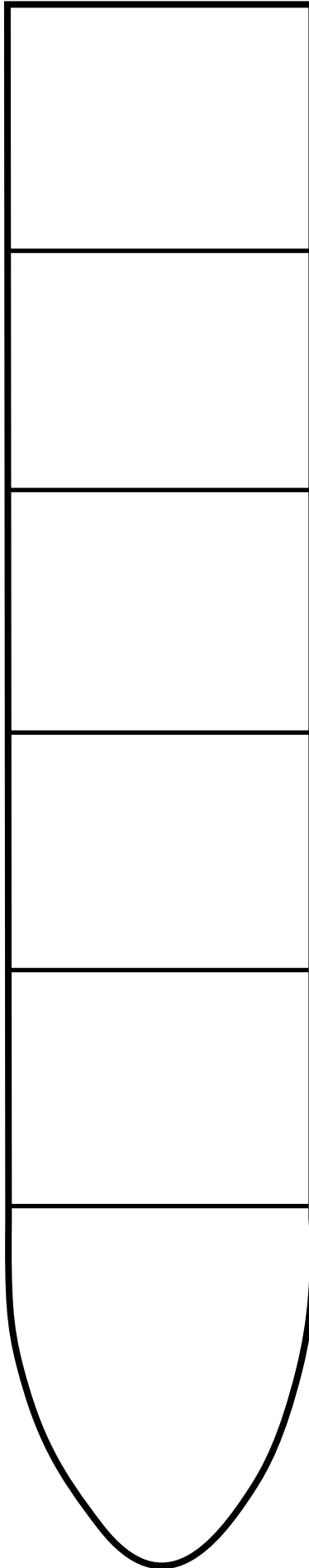
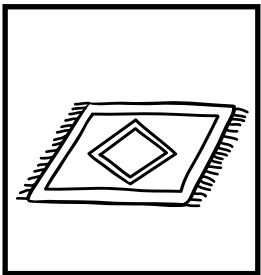
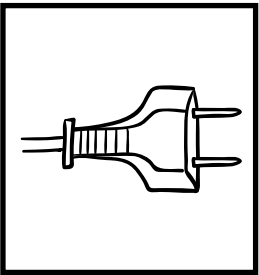
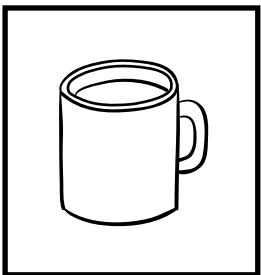
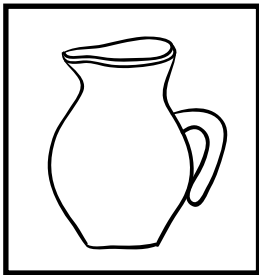
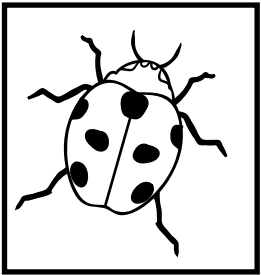
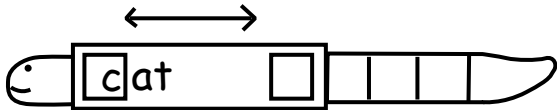
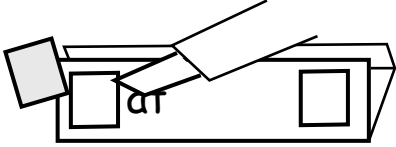

Word Family Worm(I): -ug

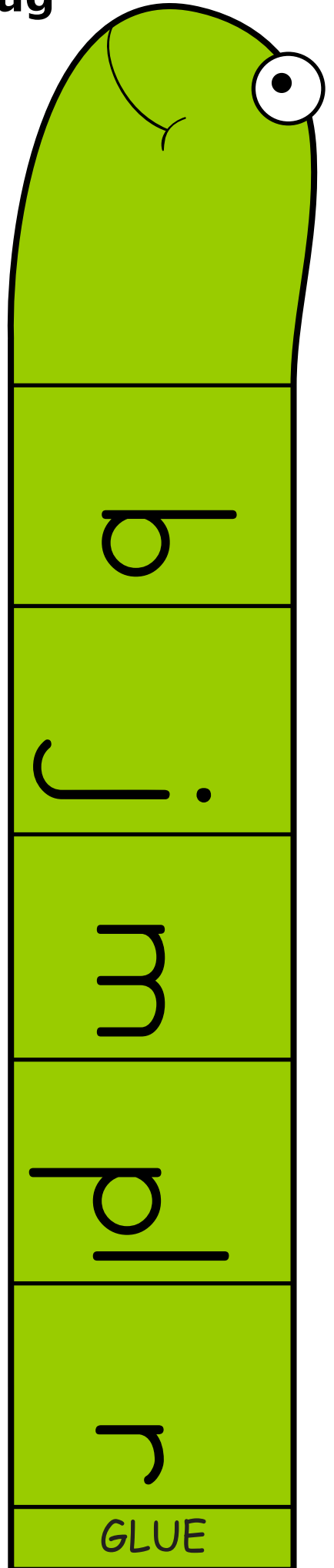
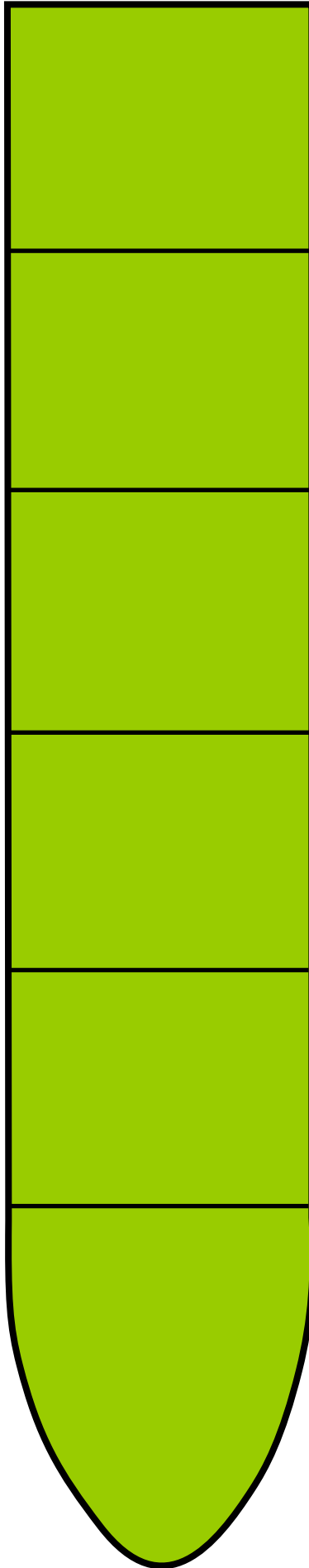
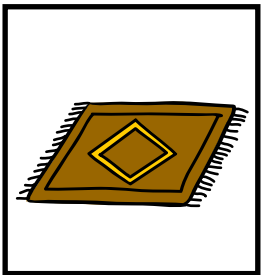
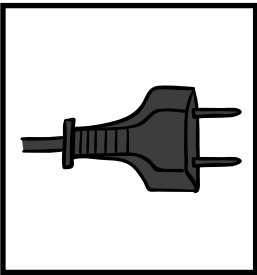
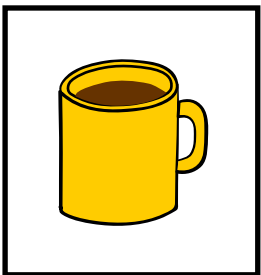
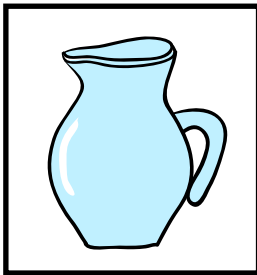
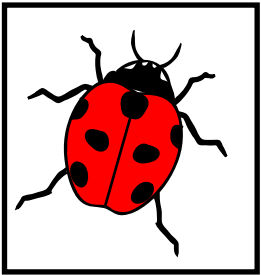
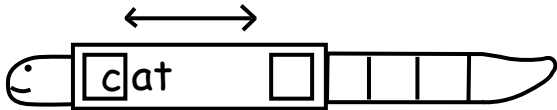
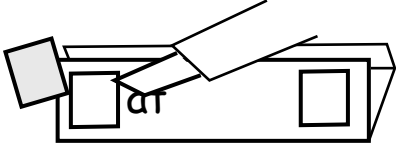

h

j

m

p

r

GLUE

GLUE

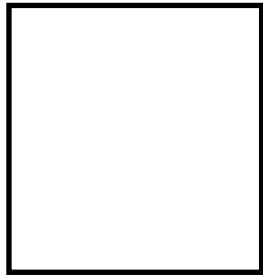

bn

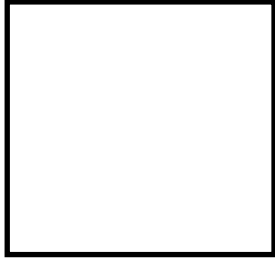

The -ug Family

____ ug

____ bn

____ ug

____ ug

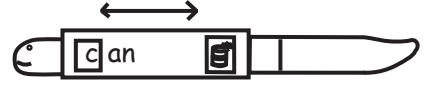

____ ug

Word Family Worm(II): -ug

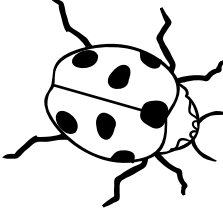
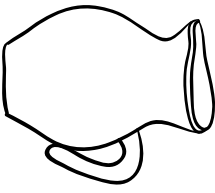
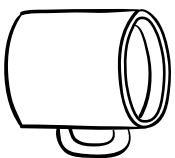

Cut slits on the -an card. Glue the worm strips together. Thread the worm through the slits on the card.

an



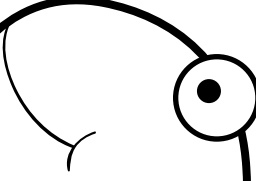



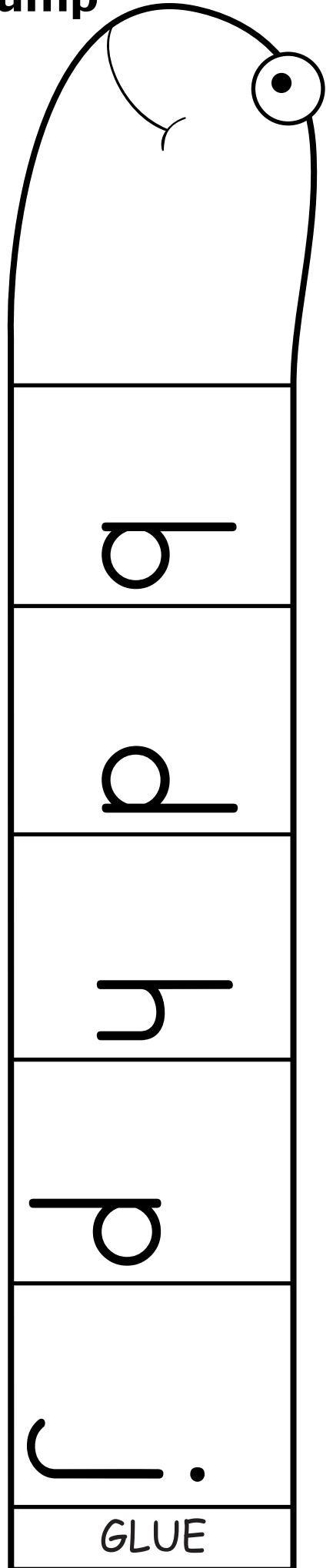
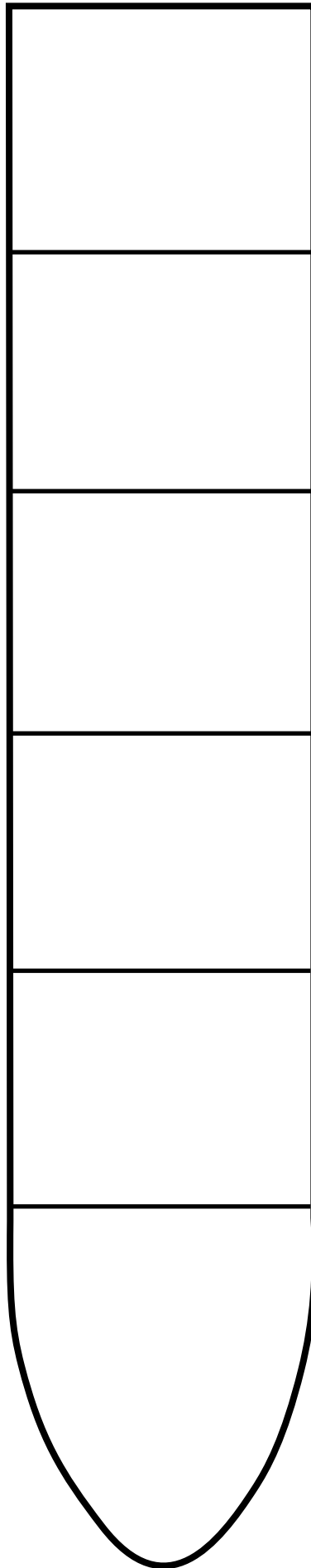
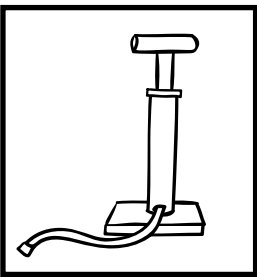
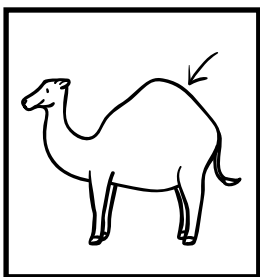
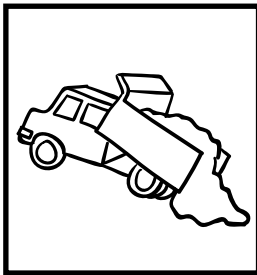
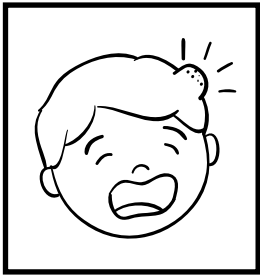
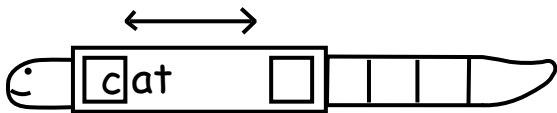
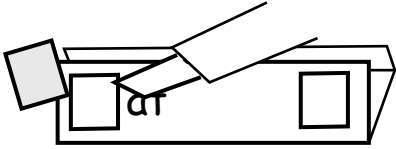

a
i
m
p
r
GLUE

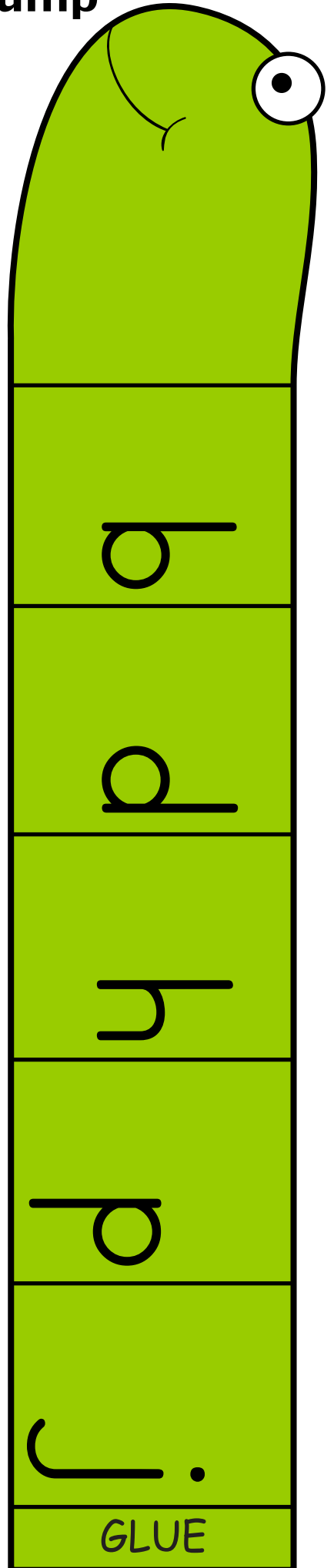
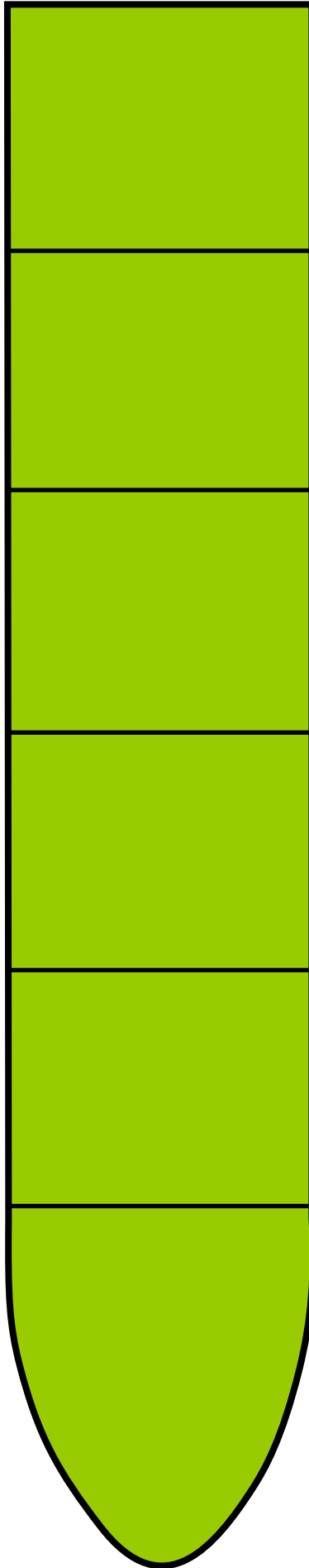
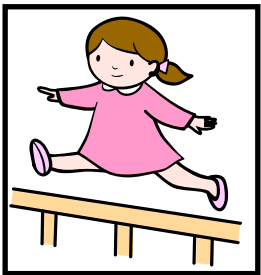
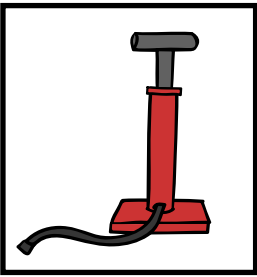
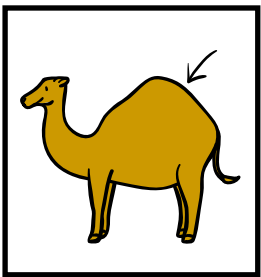
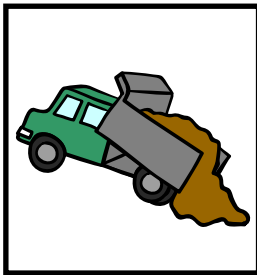
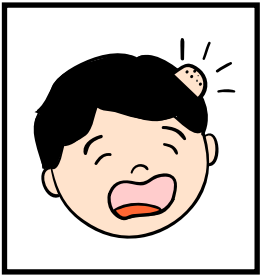
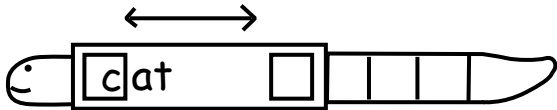
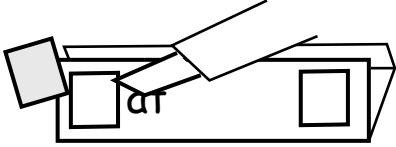
Word Family Worm(I): -ump



Word Family Worm(I): -ump



GLUE

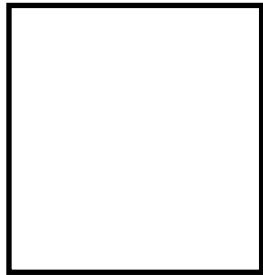

dun

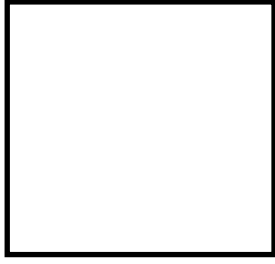

The -ump Family

____ ump

____ ump

____ ump

____ dun

____ dun

Word Family Worm(II): -ump

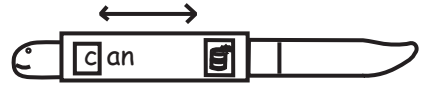
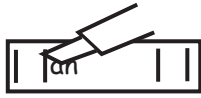

Cut slits on the -an card. Glue the worm strips together. Thread the worm through the slits on the card.

ump

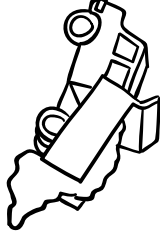
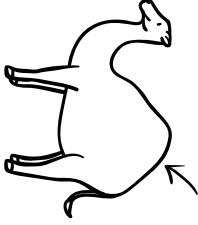
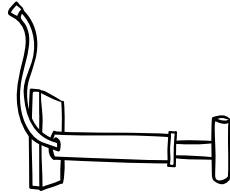
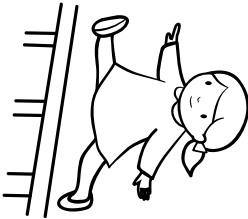

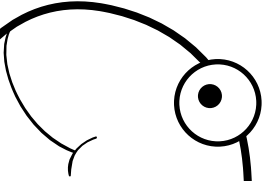



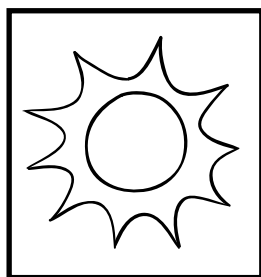
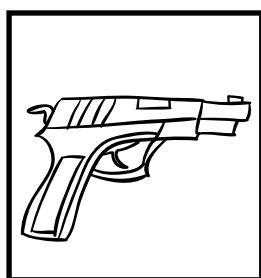
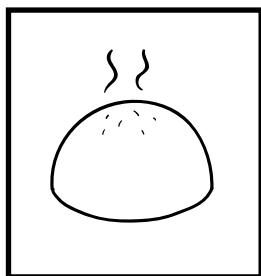
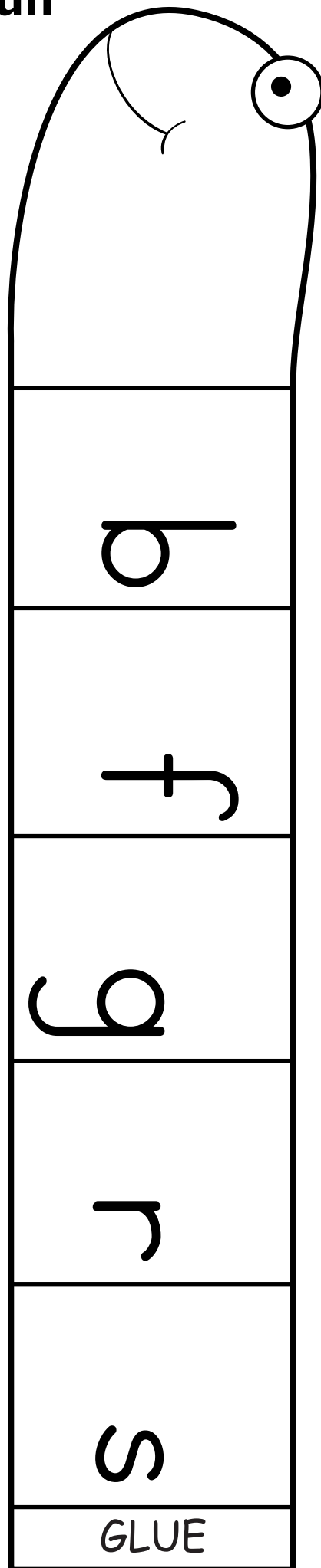
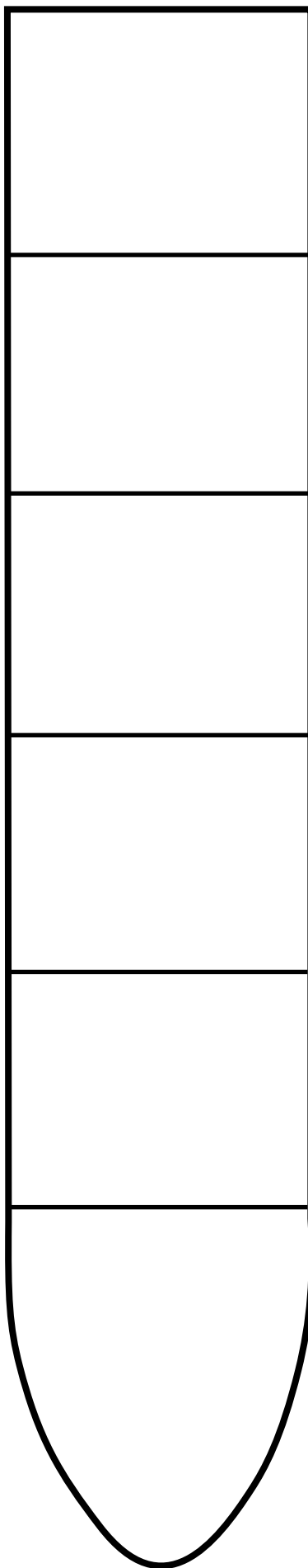
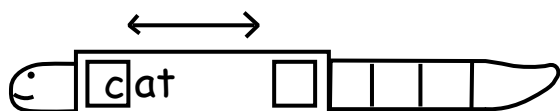
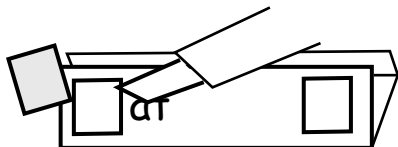
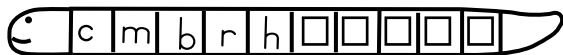

a
p
h
d
l.
GLUE

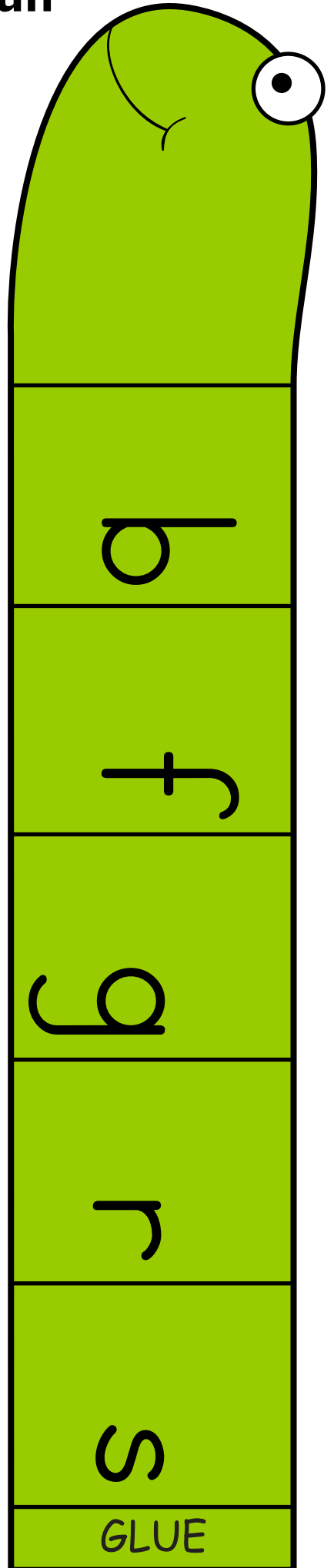
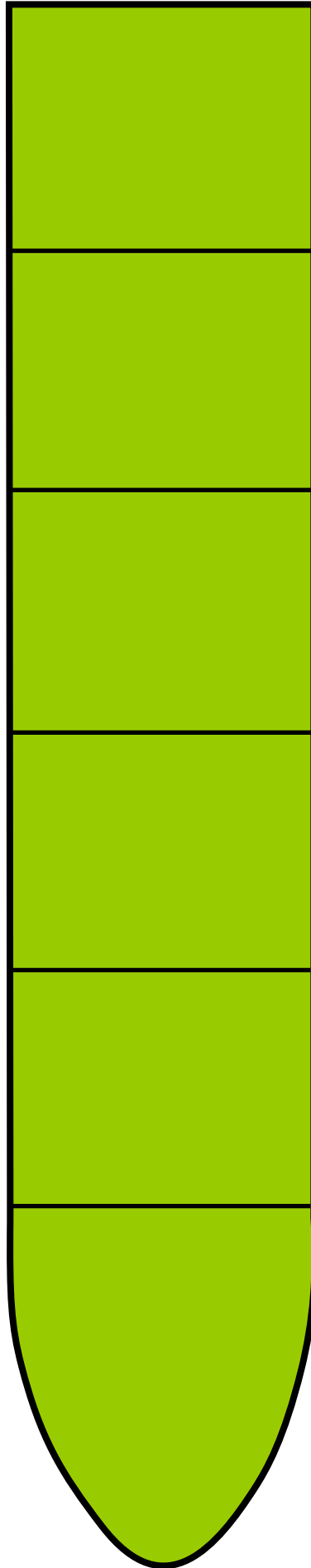
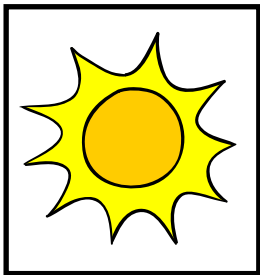
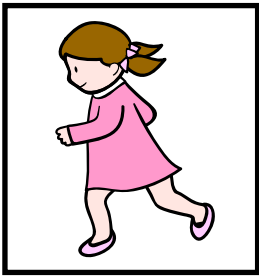
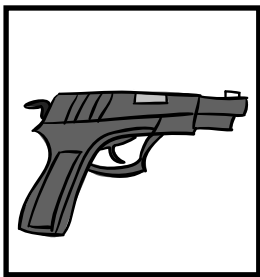
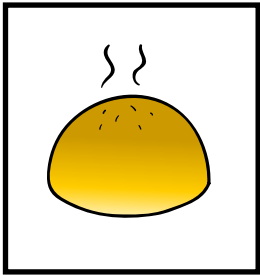
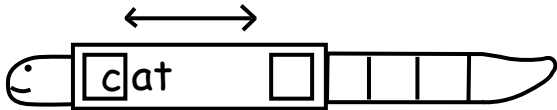
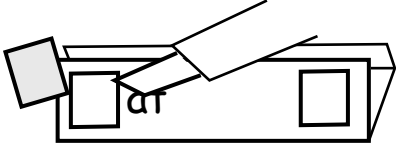
Word Family Worm(I): -un



Word Family Worm(I): -un



GLUE

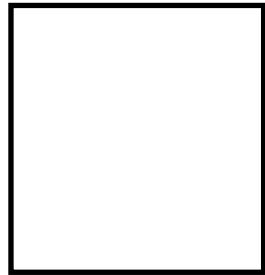

un

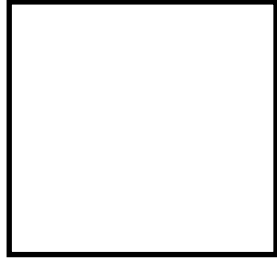

The -un Family

_____ un

_____ un

_____ un

_____ un

_____ un

Word Family Worm(II): -un

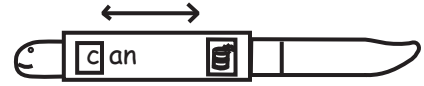

Cut slits on the -an card. Glue the worm strips together. Thread the worm through the slits on the card.

un

